

MERIT BADGE SERIES



CYCLING



BOY SCOUTS OF AMERICA®

Requirements

1. Show that you know first aid for injuries or illnesses that could occur while cycling, including hypothermia, heat reactions, frostbite, dehydration, insect stings, tick bites, snakebites, blisters, and hyperventilation.
2. Clean and adjust a bicycle. Prepare it for inspection using a bicycle safety checklist. Be sure the bicycle meets local laws.
3. Show your bicycle to your counselor for inspection. Point out the adjustments or repairs you have made. Do the following:
 - a. Show all points that need oiling regularly.
 - b. Show points that should be checked regularly to make sure the bicycle is safe to ride.
 - c. Show how to adjust brakes, seat level and height, and steering tube.
4. Describe how to brake safely with foot brakes and with hand brakes.
5. Show how to repair a flat. Use an old bicycle tire.
6. Take a road test with your counselor and demonstrate the following:
 - a. Properly mount, pedal, and brake, including emergency stops.

- b. On an urban street with light traffic, properly execute a left turn from the center of the street; also demonstrate an alternate left-turn technique used during periods of heavy traffic.
 - c. Properly execute a right turn.
 - d. Demonstrate appropriate actions at a right-turn-only lane when you are continuing straight.
 - e. Show proper curbside and road-edge riding. Show how to ride safely along a row of parked cars.
 - f. Cross railroad tracks properly.
7. Describe your state's traffic laws for bicycles. Compare them with motor-vehicle laws. Know the bicycle safety guidelines.
8. Avoiding main highways, take two rides of 10 miles each, two rides of 15 miles each, and two rides of 25 miles each. You must make a report of the rides taken. List dates, routes traveled, and interesting things seen.*
9. After fulfilling requirement 8, lay out on a road map a 50-mile trip. Stay away from main highways. Using your map, make this ride in eight hours.

*The bicycle must have all required safety features. It must be registered as required by your local traffic laws.



Contents

Introduction	5
Types, Parts, and Fit	7
Maintenance	23
Equipment	37
Riding Skills	49
Touring	65
Mountain Biking	75
Cycling and First Aid	80
Improving as a Cyclist	86
Appendix	88
Cycling Resources	94



Introduction

Since 1911, hundreds of thousands of Scouts have made the most of their two-wheel adventures—alone and with fellow Scouts, friends, and family—by earning the Cycling merit badge. Whether you just got your first bicycle or have been cycling for years, you will learn more about your bike and what it can do by working on the requirements for this badge.

This pamphlet is your guide to the basics of bike types, repairs, maintenance, equipment, riding skills, and touring and off-road cycling, and to the importance of safety in every one of these areas—information you will need to fulfill the requirements. Bike parts that appear in boldface type can be identified in the diagrams in the appendix. The Boy Scouts of America Bike Safety Guidelines in the appendix outline the dos and don'ts of responsible riding. The list of cycling publications and organizations in the resources section of this pamphlet is a good place for you and your merit badge counselor to begin seeking more detailed or specialized information.

As a Scout, you already know the importance of being fit, learning new skills, reaching your goals, and respecting the environment. You probably understand, then, why cycling is more popular than ever in the United States. Becoming a more skilled and knowledgeable cyclist now is the key to a lifetime of adventure and accomplishment on roads and trails in your neighborhood—and all over the world.





Types, Parts, and Fit

Types

Bicycles today can be classified into major categories by the style of riding intended for each type: BMX, comfort and hybrid, ATB (mountain), and road bicycles. Each class has its own strengths and weaknesses, and many bikes combine features of different classes.



BMX Bicycles

These durable bikes are made for trick riding—track and vert (or “vertical,” in reference to the tops of stunt ramps) riding, jumping, flipping, spinning, and other stunts. The small frames are strong, stiff, lightweight, maneuverable, and built to absorb intense shock. Some BMX bikes have a rotor attached to the stem, allowing the rider to spin the handlebars 360 degrees without tangling the brake cables. The wheels are small (20-inch), and the handlebars are slightly upright for greater maneuverability and stability.

Comfort and Hybrid Bicycles

Comfort and hybrid bicycles are intended for the casual rider taking short trips. Most have medium-width **tires**, a single speed, and fixed gearing. However, a few have five speeds with a **rear derailleur**. The **pedals** are basic models with rubber treads; the **handlebars** usually are raised; and the single-speed models have **coaster brakes** while the multispeed ones have **hand brakes**.

All-Terrain Bicycles

Mountain bikes, or ATBs, are intended for use on trails and in the mountains. These bikes are built for power and maneuverability. Among their features:

- Sturdy construction—A smaller **frame** than a road bike, high pedals for greater ground clearance, flat handlebars that make handling easier
- Versatile gearing—Twelve to 24 gears and rear and **front derailleurs** that allow for biking on many kinds of terrain
- Fat, knobby tires for greater rolling resistance
- Hand brakes that allow quick, controlled braking



The features that make ATBs ideal for rugged ground also make them less suitable for longer trips on improved surfaces.

Road Bicycles

Road bicycles are built for riding long distances and racing. Among their features:

- Dropped handlebars that permit a choice of riding positions: higher for slow riding, visibility in traffic, and change of posture; lower when speed and reduced wind-resistance are desired
- Narrow, high-pressure tires made with modern materials that are lightweight, can withstand damage, and reduce rolling resistance
- Front and rear derailleurs that produce 10 to 24 different gear combinations, and controls mounted on the downtubes or at the **handlebar ends** for frequent, easy shifting
- A smooth, narrow **saddle** positioned forward on the bike to put the cyclist's weight over the pedals, in the best position for generating power and for long periods of riding



Road bikes are designed to reduce rolling resistance and wind resistance.

Parts

Brakes

Bicycles may be equipped with coaster brakes—also called hub brakes—or hand brakes, also known as rim brakes. Coaster brakes are housed in the hub of the rear wheel and are applied by pedaling backward. While they are enclosed in the hub and thus protected from the weather, coaster brakes have several disadvantages: They take slightly longer to apply than hand brakes and can only be applied when the pedals are in position for pedaling backward. The brakes are applied only to the rear wheel and are not as effective as brakes applied to both wheels.

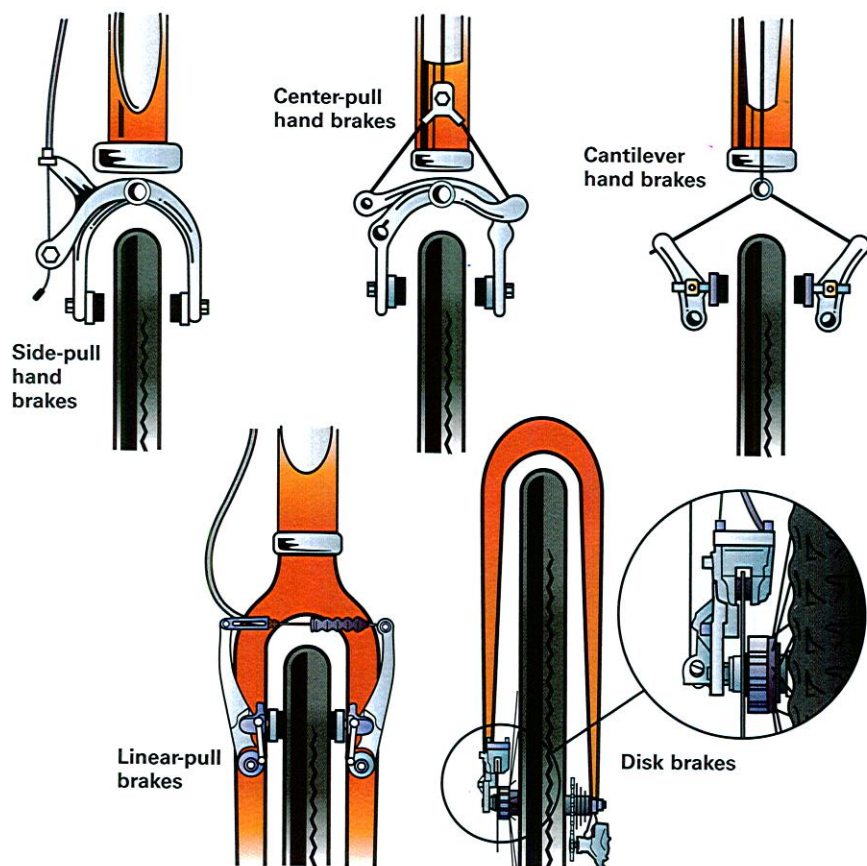

Levers mounted on the handlebars control hand brakes. Operating through flexible **cables**, they cause rubber **brake pads**, or blocks, to be pressed against the rims of the wheel. When the brake levers are fully squeezed, there should be at least an inch of clearance between the levers and handlebars.

While hand brakes generally are considered to provide more effective braking, they require frequent adjustment. Cables must be checked often and occasionally replaced to prevent sudden snapping. Braking response can be greatly affected by moisture and dirt on the wheel rims.

Higher-end mountain bikes are usually equipped with either disk brakes or linear-pull brakes. Some bikers prefer disk brakes because they are more dependable in wet or muddy conditions and give the rider more stability on slippery surfaces, and they are reasonably priced. However, the latest technology in brake systems is linear-pull brakes. For the avid mountain biker, linear-pull brakes provide powerful stopping power. Both disk brakes and linear-pull brakes require relatively high maintenance, so it's best to consult with a reputable bike shop about the right type of braking system for you.

Gearing

There are three main types of gearing: fixed gearing, multi-speed internal gearing, and derailleur gearing.

While fixed gearing on any particular bike may be high, low, or in between, it cannot readily be changed. You cannot vary fixed gearing as you ride. The typical utility bike has an average gear ratio; however, you might be able to select one with a gear ratio that suits your special needs. If most of your riding is likely to be up and down hills, a low gear ratio makes climbing hills easier. If you want speed or are likely to do most of your bicycling on flat, smooth roads, higher gearing may be in order.

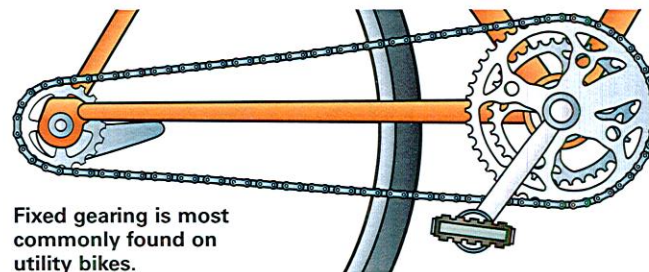

Fixed gearing is most commonly found on utility bikes.

Normally, a set of brakes on the front wheel and another on the rear wheel are controlled by separate handlebar levers.

Bikes with multispeed internal gearing usually have three or five speeds. The lowest-numbered gear is for pedaling uphill or against strong winds. The highest-numbered gear is for traveling at a higher speed downhill or with a tailwind.

Multispeed internal gearing operates in the hub of the rear wheel and is connected by cable to a control lever on the handlebar.

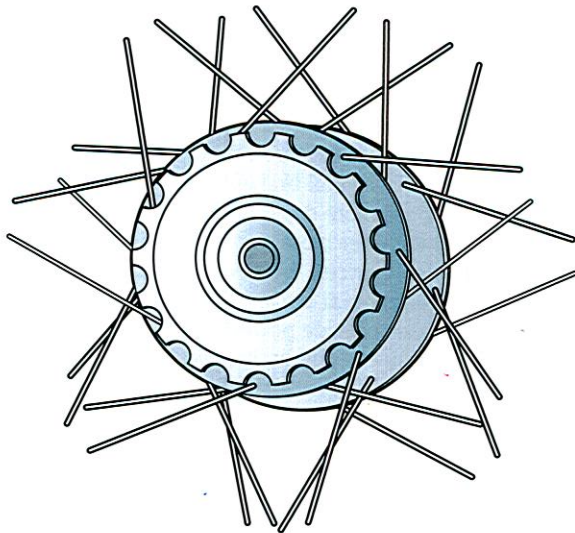

The number of possible gear combinations on a derailleur-equipped bicycle is determined by multiplying the number of sprockets on the rear hub by the number of **chainrings** at the pedals. For example, a bike with seven rear sprockets and three chainrings has 21 gear combinations. Gearing available today ranges from five to 24 speeds.

To shift gears, the derailleur moves the **chain** from one sprocket to another, or from one chainring to another, or both. The chain passes through a guide, or cage, which moves it to the various sprockets or chainrings as needed. This cage is connected by a flexible cable to a control mechanism convenient to the rider's hands.

Devices that control the derailleur come in a variety of styles. They can be

- Levers mounted on the downtube
- Levers mounted on dropped handlebars
- Thumb-**shifters** mounted on straight bars
- Twist-grip shifters that work through the **handlebar grips**
- Ergonomic shifters that work in conjunction with brake levers

The shifters can work in two modes: indexed or friction. A "click stop" in the indexed system precisely controls the shifting of the derailleur. Each click of the shifter moves the derailleur one gear. The friction-style shifter has an infinite range of movement. To shift gears, you have to move the lever until the gears change, then adjust the lever to fine-tune the mechanism so that the gears produce as little noise as possible. Front-derailleur shifters almost always operate in the friction mode, but in an emergency, all shifters have the capability of operating in this mode.

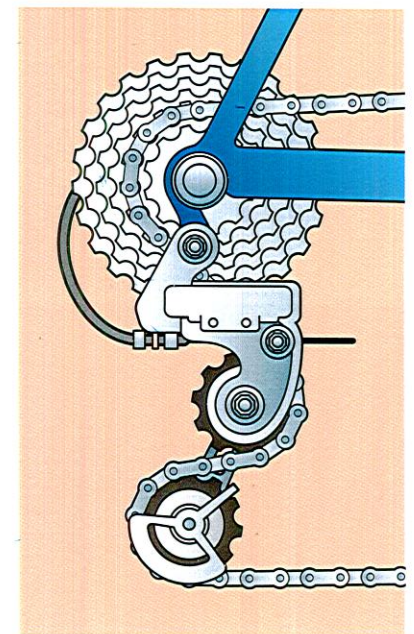
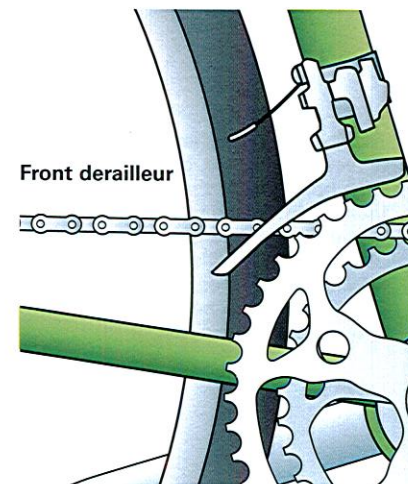

Wheels and Tires

Wheels can be described several ways.

- *Diameter* is measured in either inches (the nonmetric system) or millimeters (the metric system). Note that even though the two dimensions might be roughly the same size, they are not interchangeable.
- The *number of spokes* varies according to the bike's intended use and rider. In general, a wheel will have more and thicker spokes if it is to be used in rougher conditions or by a heavier rider. For example, a road bike may have 36 spokes per wheel, while a tandem bicycle (for two or more riders, one behind the other) may have 48 spokes for the same diameter of wheel.

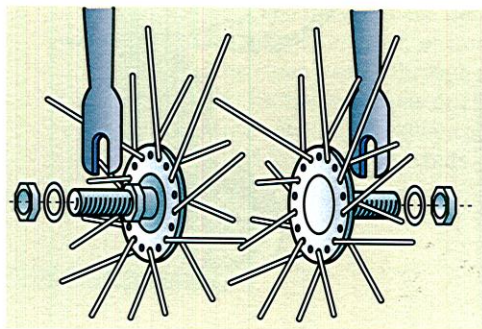
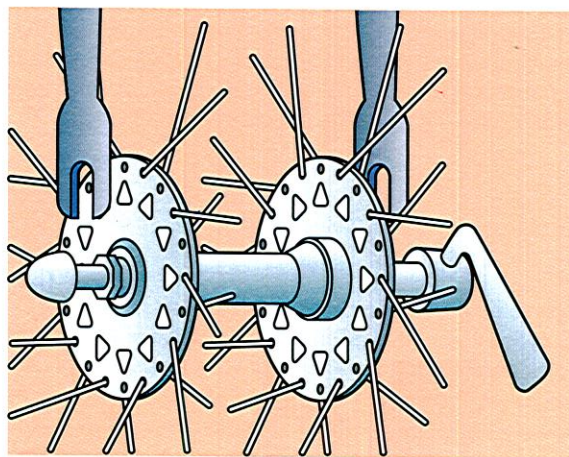

Two types of hubs are used for wheels. Some, left, have solid axles with hex nuts on their ends to keep them tight on the forks, or dropouts, of the bicycle. The quick-release hub, above, has hollow axles through which a rod passes, permitting the rapid installation and removal of a wheel from the bicycle.

- Bike wheels generally are made from one of two *materials*: steel or anodized aluminum. Steel wheels are found on less costly bikes, are slightly heavier than aluminum wheels, and in wet conditions do not work as well as aluminum with hand-operated brakes.
- *Rim construction* can vary, but virtually all rim-and-tire combinations on bikes (other than ultra-high performance bikes) have “clincher” or “wired-on” rims.

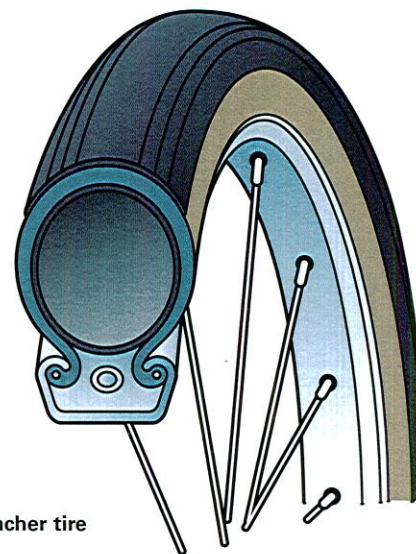

Clincher tire

In a clincher tire, the inflated tube presses the wire-embedded edge of the tire casing outward, holding it secure against the wheel.

Like wheels, tires are sized in inches or millimeters. To find the size of a tire, look on the label of the tire or on its sidewall. The first number is the wheel diameter and the second, the width of the tire.

Tubes are nothing more than the rubber bladders that hold air and expand inside the tire. They come sized to fit a range of tires, which in turn must match the size of the rims. Many tubes are sized 27 × 1 to 1¼, or 700 × 25 to 32. Such tubes are appropriate for nonmetric-sized tires measuring 1 inch through 1¼ inches, or for metric-sized tires measuring 25 through 32 millimeters.



Road bikes use what most people call “narrow tires,” which are not much wider than the rims they are mounted on. A narrow tire, *far left*, must be inflated to a higher pressure—above 70 psi, or pounds per square inch. In contrast, a mountain bike tire, *near left*, is wider and requires relatively lower inflation pressure.

Two types of air **valves**, the Schrader and the Presta, are used in tubes. Schrader valves are the same kind as those used in car tires. A little pin is pushed in to release the air while a spring pushes the valve out to retain air pressure. The Presta valve has a narrow, all-metal tip with a release button on the end that can be partially unscrewed. The valve floats freely once the button is unscrewed, and air pressure inside the tube pushes out on the valve to retain the air. Once the Presta tube is brought to operating pressure, the release button is screwed tight.

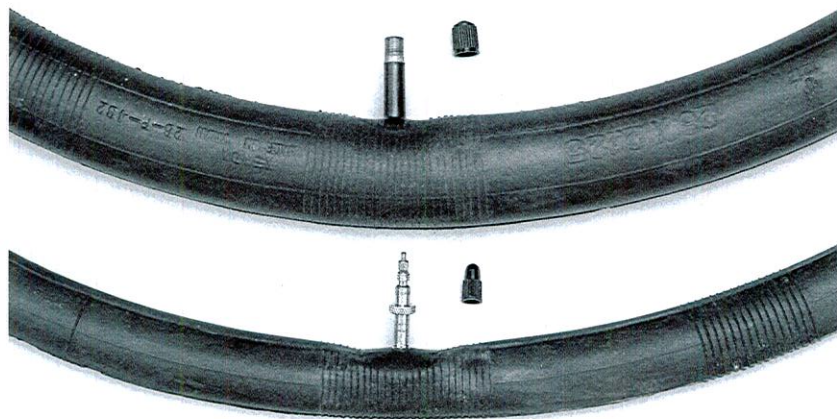

In general, you cannot use a Presta valve tube, *bottom*, in a wheel designed for a Schrader, *top*, and vice versa.

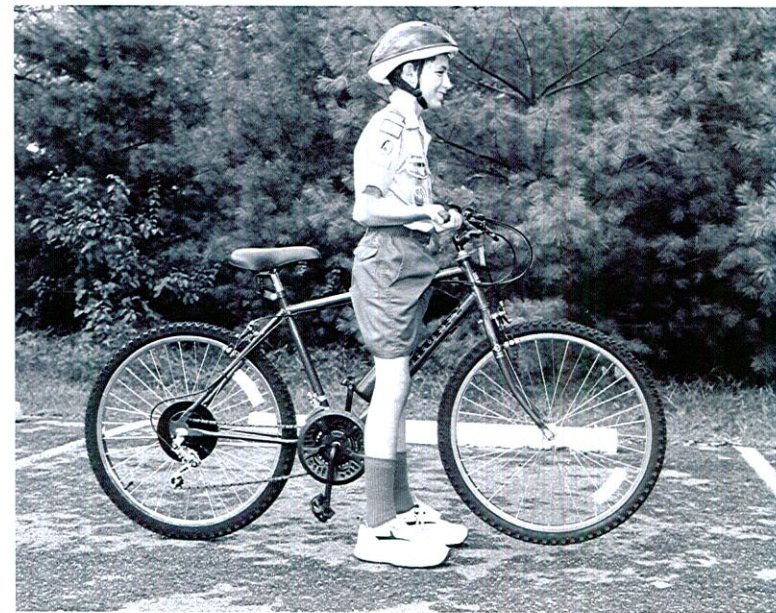

To check the fit of a bicycle, straddle the top tube and lift the handlebars until the top tube reaches your crotch level. If the road bike fits you, there should be about an inch of space between the front tire and the ground, which allows you to dismount safely and ride with maximum efficiency. For a mountain bike, there should be 3 to 4 inches of space.

Fit

Sizing

Choosing the right size frame will help you cycle with greater efficiency and comfort. The frame size is the distance from the center of the **crankset axle** to the top of the **seatpost**—not, as is commonly believed, the diameter of the wheel.

Fitting the Saddle

To fit your body, the most important adjustment is setting the saddle height. (Adjustments to the saddle should be made with the help of an adult.) When the saddle is too low, excessive stress is placed on the knees. When the saddle is too high, you lose leverage and cannot use the cranks efficiently. The saddle should be raised so that you can just place your heels on the pedals in the six o'clock position.

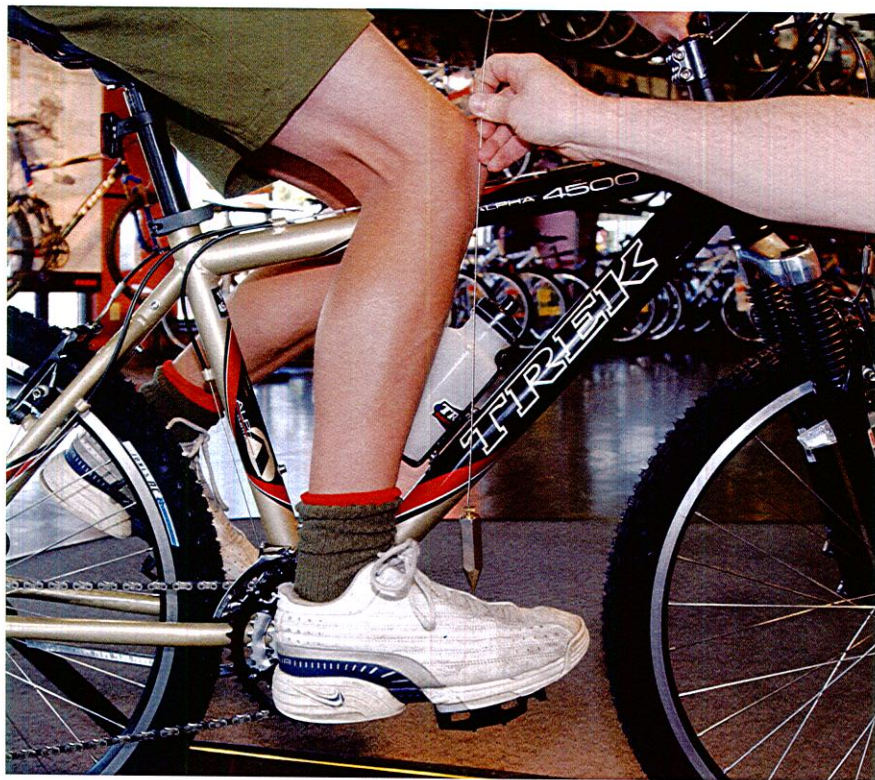

Some saddles can be adjusted forward or backward. If your saddle has this feature, ensure the correct alignment. Put the pedals in the horizontal position and center the ball of your foot on the pedal axle. Hang a weighted string next to the bottom of the kneecap of the leg that is forward. The string should pass through the center of the pedal axle. If the string is behind the axle, move the saddle forward. If it is in front, move the saddle backward.

To test the saddle's fit, put on your helmet, mount the bike close to a wall, and lean one shoulder against the wall. Place the ball of your foot directly over the axle of the pedal, then pedal backward and check your motion. As you spin the crank, your leg should be almost— but not completely— straight and there should be no rocking of the hips. After adjusting the height of the seat, make sure the saddle is level and not tilted up or down.

Fitting the Handlebars

The top of the handlebars should be about an inch below the height of the saddle. (This guideline does not apply to bicycles like a utility-style bike.)

On the handlebar stem is a line showing maximum extension. Make sure at least 2½ inches of the stem remains inside the steering tube.

These are the basic, beginning adjustments to your bike. As you ride more miles, you may find that minor adjustments will sometimes lead to large gains in comfort and efficiency.



The handlebar ends should be tilted up or down so they point to the space above the rear axle but below the top of the rear wheel, or they should be parallel to the ground. If the handlebars are in the correct position, your back should be at a 45-degree angle when you assume the riding position. If not, you may have to change to a different size stem or slightly change the height of the bars.



For a proper mountain bike fit, the back should lean forward at least 45 degrees; the head should be held so the front hub is hidden by the handlebars when looking down; and the arms should be slightly bent to help absorb shock.

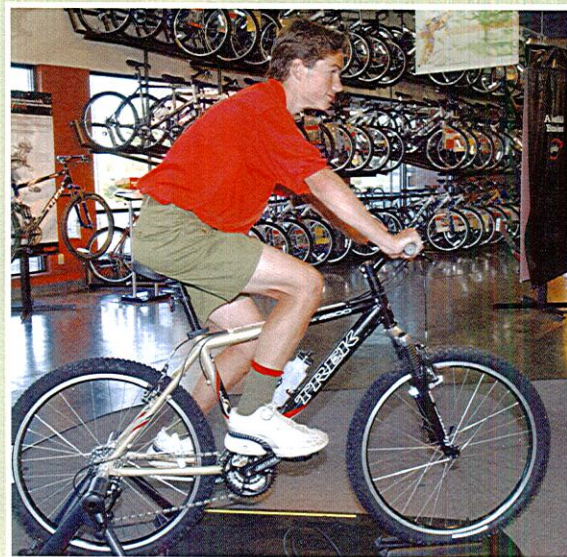
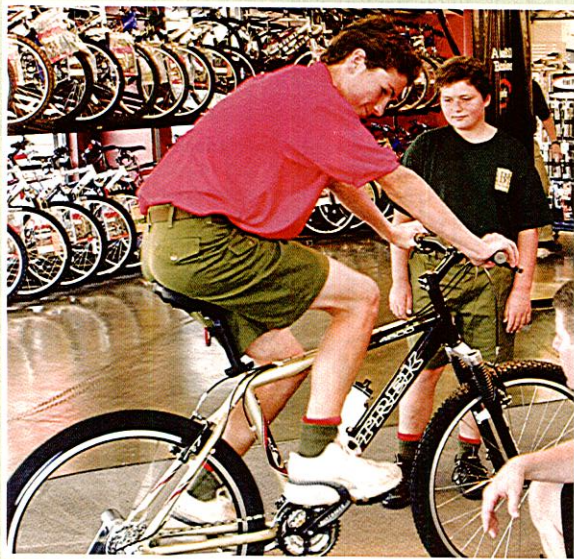



Maintenance

The bicycle is a very simple machine and will give you many miles of riding pleasure providing you schedule time to maintain it. The following information on the care of your bike is written not only to help you earn the Cycling merit badge, but also to help you get the most out of your bike.

As you read this chapter, keep in mind requirements 2, 3, and 5, and the items on the Bicycle Safety Checklist in the appendix. You can find a lot of good books detailing bicycle maintenance beyond the requirements for this merit badge at your local library or bookstore.

How much maintenance should a bicycle owner do? This depends on the bicycle and the owner. Generally, the cyclist who is mechanically inclined can service many things. Yet, cyclists should not attempt repairs or adjustments without a clear idea of what they are doing. Besides following a bicycle maintenance or repair book, getting assistance from another cyclist or a mechanic experienced in bike repair is a good way to learn. If a repair is too complicated, let the experts at a bike shop do the work.

A bicycle needs thorough professional servicing, including cleaning and repacking bearings and replacing worn cables and tires, at least once a year. If the bike is ridden long distances or in very adverse conditions, it should be serviced more often.

Bearing in mind that a little preventive maintenance goes a long way, consider doing the following **before every ride**:

- Keep your tires inflated at the correct pressure. Check tires for cracks and glass cuts.
- Clean and lubricate your chain immediately after it gets wet.
- Make sure that your brake pads are in adjustment and not too worn, your cables are taut and not frayed at the ends, and any quick-release mechanisms are fastened correctly.

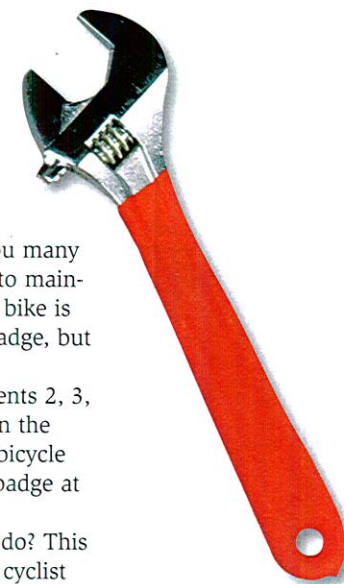

Tools

Most bikes have metric-sized nuts and bolts. Some have non-metric ones. It is important to know which nuts and bolts your bike has so that you can use the correct tools. Except in an emergency, do not use adjustable tools to turn nuts and bolts because these tools tend to round or strip the corners of the fasteners. Instead, use the correct size of box, open-end, or Allen wrench.



SCREWDRIVERS

- 1 Standard (slotted), $\frac{1}{8}$ inch and $\frac{3}{16}$ inch
- 2 Phillips, small and medium heads; used on derailleur-adjustment screws and accessory-mounting screws

WRENCHES

- 3 Box or open-end wrenches, 8 to 17 millimeters (1-millimeter increments) or $\frac{5}{16}$ inch to $\frac{3}{4}$ inch ($\frac{1}{16}$ -inch increments); used for various nuts and bolts
 - 6-inch and 12-inch adjustable wrenches; used for adjusting brake toe-in and headset-bearing work
- 4 Allen wrenches, standard $\frac{1}{8}$ inch to $\frac{3}{8}$ inch or 4 to 8 millimeters

PLIERS/CUTTERS

- 5 Vise grip-type pliers, locking 6-inch; used for grabbing bolts rounded by adjustable wrenches
- 6 Channel locks, 6- to 8-inch pliers; used for general-purpose gripping
 - Diagonal cutters, 6-inch; used for cutting cable, cable housing, and toe straps
- 7 Mallet—1-pound wooden or rubber mallet; used for loosening handlebar expander bolt
- 8 FLOOR PUMP—high-pressure (150 psi) pump with built-in air gauge; used for underinflated tires
- 9 TIRE TOOLS—set of plastic, steel, or alloy tire levers; used to remove clincher tires
- 10 CHAIN TOOL—metal tool that removes rivets from chains; used to break and rejoin chains on derailleur-equipped bikes

Except for the floor pump, tire tools, and chain tool (which can be purchased at bike shops), the tools pictured usually can be found around the house or obtained from the local hardware store.

Cleaning and Lubricating

You should devote some time each week to inspecting, cleaning, and lubricating your bicycle. If you ride fairly often, you should check the condition of your bike more frequently. By finding potential trouble spots early, you can avoid breakdowns.

In general, the parts of the bike that are not lubricated can be cleaned with a soft brush, a rag, and a mild detergent solution. These include the spokes, wheel rims, and tires. After washing, rinse and dry everything well.

All painted parts of the bicycle can benefit from an application of car wax, which makes cleaning easier the next time. The film of oil and dirt should be removed from the rims of the wheels so that the brakes will work smoothly and effectively. After washing the wheels with soap and water, rub a synthetic scrubbing pad over the rims to clean them to the bare metal. Then wipe the rims with a clean, dry rag.

Never wash your bike with high-pressure water (as in a drive-through car wash) because water will be forced into bearings, causing rust.

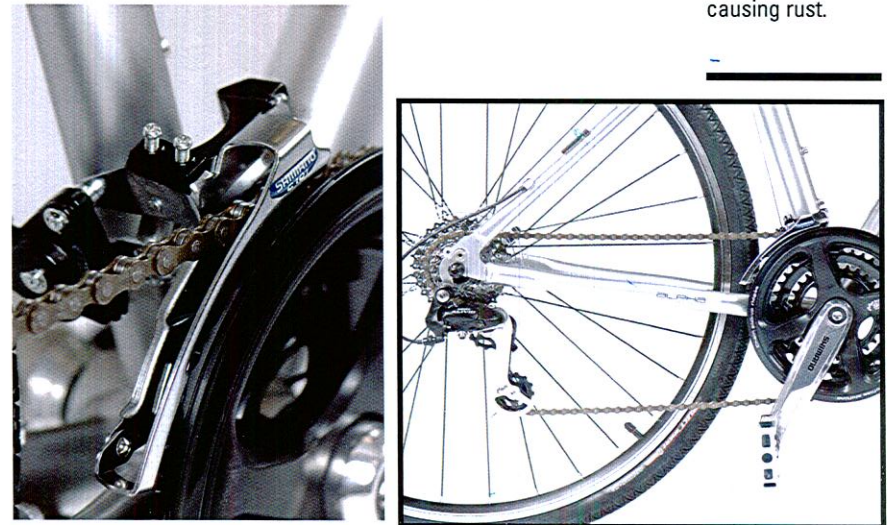

A good time to inspect the drive train and the rest of the bike for worn or broken parts is right after it has been cleaned.

Cleaning lubricated components is a little messier. Spread plenty of newspapers to protect the surface below the bicycle. Use an old toothbrush with a little bit of lubricating oil to brush off any accumulated dirt and lubricant from the rear cogs, the derailleur pulleys, the crankset, and the chain. Wipe the parts with a rag to remove most of the remaining dirt from the components. Then carefully clean each component by wiping it with a rag that has been dampened with a lubricant. All the grime should be removed with this step. A final pass with a clean rag will remove any lubricant used in cleaning and will leave the parts dry and ready for the next step—inspection.

Inspect the frame for bulges or cracks in the metal or paint, especially at the joints. Look at the wheels for cracks in the rim, broken spokes and spoke holes, and irregularities. Scan the whole drive train for worn, bent, or cracked parts. Make sure that every bolt and screw on the bike is tight, and check the tires for anything unusual. Damaged tires must be replaced immediately.

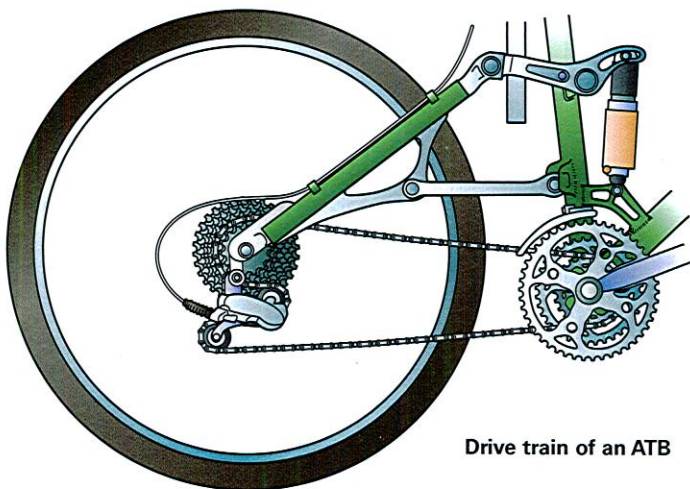

Drive train of an ATB

Lubricating

Remembering what needs lubrication on a bike is easy: Wherever there is metal-to-metal contact, or a cable slides through something, lubricate. “Less is best” is a good rule for lubricating. Always wipe away excess lubricant, and prevent overspray by holding a cloth behind the part you are lubricating. Remember, though, that the more exposed the part or the more it moves, the more frequently it must be lubricated.

High-quality lubricant specifically formulated for bikes should be used for lubrication of all closed (contained) components, such as the **wheel bearings**, the **headset**, and the **bottom-bracket bearings**. High-quality, water-resistant lubricants containing silicone are recommended for open (exposed) components. Do *not* use common household oils. Their sticky composition traps dirt, which adds to unwanted abrasion between the moving parts. A bike shop can recommend the appropriate lubricants.

The following chart lists bike components by the recommended frequency of lubrication.

Component	Lubricant	How to Lubricate	When to Lubricate
Chain	Silicone-based	Use a drop of lubricant and wipe.	When dry, after rain, weekly
Derailleur pulleys	Silicone-based	Use a drop of lubricant and wipe.	When dry, after rain, weekly
Derailleurs	Silicone-based	Use a drop of lubricant and wipe.	Monthly
Cable ends	Silicone-based	Wipe with lubricant-dampened rag.	Monthly
Brake calipers	Silicone-based	Use a drop of lubricant and wipe.	Monthly
Brake levers	Silicone-based	Use a drop of lubricant.	Every six months
Freewheel	Silicone-based	Wash in solvent, lubricate, and drain.	Every six months
Handlebar stem and seatpost	Grease	(See text)	Annually (see text)

The **handlebar stem** and seatpost are two parts that do not move but must be lubricated nonetheless to prevent them from corroding and jamming in their tubes. First, find and mark the height of each one (you could wrap masking tape around the stem and post). Remove each part. Clean and lubricate the tube in which it was mounted; clean and grease the seatpost, or stem; reinsert each part at its previous height. Do not overtighten the clamping bolts on these components. The seatpost bolt only has to keep the seat from sliding down. Tighten the stem bolt enough to hold the handlebars against most usual cycling forces.

Brakes

Keeping hand brakes in good working order is the maintenance task you will perform most frequently, except for maintaining air pressure in your tires.

Brakes are the most important components on a bicycle because they stop a bicycle in motion or help control its speed on a descent. They should function at maximum efficiency all the time. Coaster brakes should be adjusted and serviced only by a bicycle repair specialist. A Scout can adjust hand brakes, though, with just a little effort.

For the remaining adjustments, be sure your wheels are true, or balanced. To check, spin the wheel. If it has a noticeable side-to-side wobble or up-and-down "hop," it is not true. Bike shops are well-equipped to true wheels.

Brake Blocks and Shoes

First, check the brake blocks, or pads, for wear. If there is less than $\frac{1}{8}$ inch of rubber outside the brake shoe, or pad base, or if the pads are glazed and hard, replace both brake blocks on that assembly. To make sure you get the correct replacements, take the old blocks to a bike shop as examples. Worn brake blocks can be shaped with a file or sandpaper to remove any "shelves" formed on the blocks from riding below the rim. The file also will remove any glazing from the surfaces of blocks.

After pulling the main brake cable taut through the anchor bolt, tighten the bolt. Now squeeze the brake lever hard several times to see if anything slips. Nothing should. After releasing the brake blocks from contact with the rim, turn the barrel adjuster to move the brake blocks so they just clear the rim as you spin the wheel. Now center the brakes on both sides of the rim. Side-pull brakes can be rotated after their mounting bolts are loosened. Center-pull brakes are adjusted by regulating the spring tension on each arm at the pivot point.

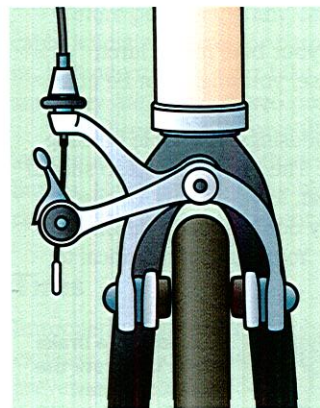

Loosen the main anchor bolt. On side-pull brakes, this bolt is on the arm. On center-pull brakes, this bolt is on the bridge-wire hook. The main brake cable is now free to move, and you can adjust the brake pads so that they are aligned with the side of the rim when moved against the rim.

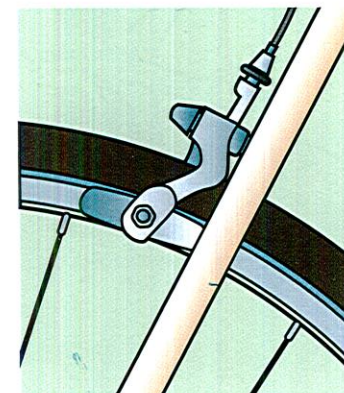

The brake blocks should not ride above the rim on the tire, nor should they extend below the side of the rim.

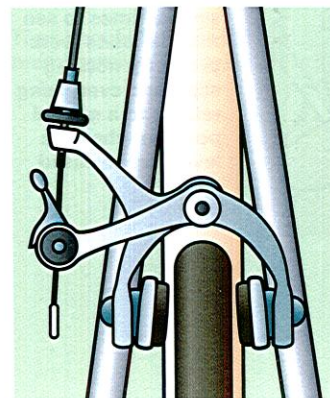

The front edge of the brake block should be "toed in" to contact the rim slightly before the rear edge. To make this adjustment, gently bend the flat surfaces of side-pull brake arms, or adjust the shaped washers on center-pull brakes. Once the brakes are aligned with the rim, hold the brake blocks using a friend, a third-hand tool, or a piece of string, then tighten their mounting bolts to secure them. You also can follow this procedure to remedy squeaky brakes.

Brake Cables

If your brake cables are too tight, your bike might lurch when stopping. If they are too loose, you might not be able to brake effectively.

Inspect the brake cables and housings. If a cable housing has any kinks or crimps, replace it. The brake cable also should be replaced if there are signs of wear, loose strands, or rust on the outside. Indeed, if you have any doubt about your brake cables and housings, replace them. Your brakes are critical to your safety.

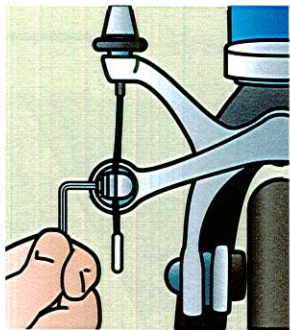

To adjust your brake cables, loosen the anchor bolt.

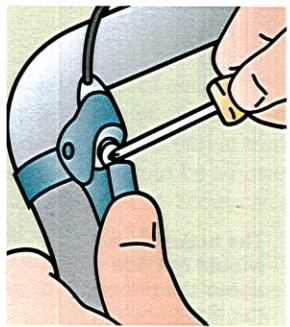

Squeeze the brake lever. Unscrew the barrel adjuster. This frees the cable for loosening or tightening. Increase or decrease cable tension using pliers. Holding the cable in place, screw in the barrel adjuster.



Tighten the anchor bolt. Then check the tension and readjust, if necessary.

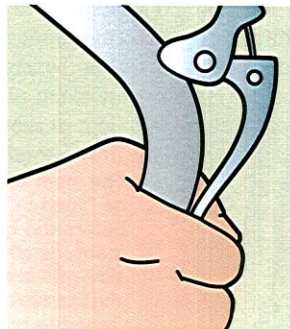

After the brakes are centered, check the whole brake system by squeezing the lever several times to see that the parts work promptly, nothing slips, and everything returns to a natural position when the levers are released.

Before performing any cable adjustments, make sure the cable-adjusting barrel, or barrel adjuster, is screwed all the way in, less one turn. If your bike has quick-release devices, make sure they are in the closed position.

Cantilever and linear-pull brakes used on mountain bikes are mounted differently than side-pull and center-pull hand brakes. However, the same kinds of adjustments are necessary: rim clearance, pad alignment, and toe-in.

Tires

Improperly inflated tires probably cause greater maintenance expense than any other part. Underinflated tires result in preventable cuts and damage to tires, tubes, and rims. Use only a frame or hand pump to inflate your tires. Service station air supplies can blow out tires.

Check your tires frequently for breaks, cracks, and worn treads. Replace tires that are suspect in any way.



Tires should be kept inflated to the maximum pressure recommended by the manufacturer. This pressure is stamped on the side of the tire.

Fixing a Flat

Removing a flat tire from the wheel completely makes it easier to find the cause of the flat and to put everything back together without damaging the tube. Do not rush, and do not skip any of the steps. By being patient and following the procedure, you will be less likely to have recurring flats.

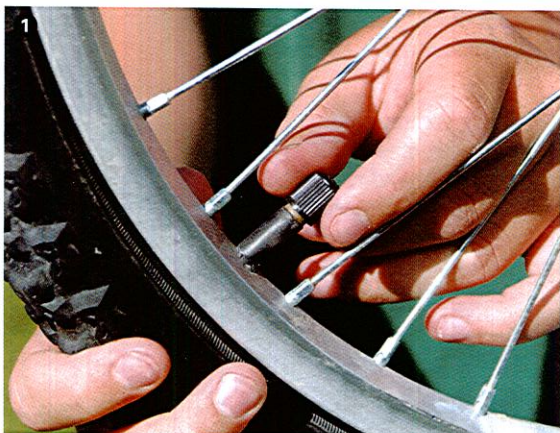

Step 1—First, check to see if the reason for the flat is the valve. The core in Schrader-type stems can be tightened, but tubes with Presta-type stems will have to be replaced.



Step 2—If the flat is on the rear wheel, turn the crank by hand and shift to the smallest cog on both the cassette and chainring. Deflate the tire completely, release the brakes if possible, and remove the wheel from the bike. For Presta-type valves, remove the nut from the stem.

Step 3—Slip your favorite tire tool between the rim and the tire on the side of the wheel facing you. Slide the tool around the rim until the tire is loose on that side. Then, starting at a point opposite the valve stem and leaving the tube inside the casing, remove the wheel completely. Lay the tire on top of the wheel exactly the way it was before it was removed. Pull the tube from the tire, maintaining the relative position of the casing and tube.



Step 4—Locate and remove any sharp object that might have caused the flat. Be absolutely sure the object is gone before you continue. Inflate the problem tube with enough air that you can find any holes by feeling or hearing the air escape.



Step 5—Follow the procedures below to fix the flat, or simply replace the tube and/or tire.

- a. *Using a boot.* If the hole in the tire casing is bigger than the head of a straight pin, you should repair the tire to prevent the tube from squeezing through the hole and bursting. A “boot” can be made from duct tape, a scrap of denim, a tire patch, or, in an emergency, a folded dollar bill. Place the boot over the hole inside the tire before installing the tube.



b. *Patching a tube.* Inflate the faulty tube until it starts to stretch. Listen and feel for the air leaking out of the hole. Dunking the tube in water may help detect holes that are otherwise difficult to locate. Deflate the tube completely and dry it, if necessary.

The secret to good tire patching is to get the tube clean where the patch is to be applied. Clean an area around the hole that is just a little bit bigger than the patch you will use. Apply one coat of cement. While waiting for it to dry, raise the protective backing at one corner of a patch so that the backing will be easy to remove when you are ready for it. Apply a second coat of cement and let it dry until the cement loses its shine.

Uncover the patch, being careful not to let anything touch its clean surface, and center it over the hole. The patch should stick immediately; hold it down if it does not, and make sure the edges of the patch are well-sealed. This should put the tube back in service. Tubes with more than a few patches should be replaced because patches deteriorate over time and become unreliable. Besides, tubes are relatively inexpensive.

Step 6—To make remounting the tire easier, use talcum powder to coat the inside of the tire, the bead of the casing, and the spare tube.

Try tire patches that do not require cement. They help to simplify the job.



The best place to patch a tube is at home. The best way to fix a flat along the road is to use the spare tube you have carried for just that purpose, but you should always carry a patch kit in the event you get two flats on a ride. A patch kit contains instructions, a tube of glue, assorted patches, and sandpaper or a metal object to roughen the tube so the patch will adhere.



Next, inflate the good tube with enough air to give it a soft shape, and insert the tube into the tire so that the valve stem is aligned with the label on the tire. Working with the tire and tube as a unit, insert the valve stem into the hole in the wheel, and work one end of the tire onto the wheel. The powder should allow you to do this using only your hands.

If you must use a tool to flip the tire onto the rim, be very careful not to cut the tube. If necessary, adjust the tube so that it is not pinched between the casing and the rim, and so that the valve stem is perpendicular to the rim. Starting at a point opposite the valve stem, mount the other side of the tire onto the wheel. (It may help to release a small amount of air from the tube.) Check to make sure the tube is inside the tire.

Now inflate the tire to about 30 psi and check to see that the tire is concentric on the wheel: The "witness line" molded onto the tire should be an equal distance from the rim all the way around. Adjustments can be made using your hands. Pump the tire to the maximum recommended pressure shown on the sidewall. With the help of the powder, the tire should align itself straight on the wheel. Install the wheel on the bike and reconnect the brakes if necessary, and away you go.

Carry your spare tube, along with a tablespoon of talcum powder, in doubled resealable bags. This way, the tube is already coated and the leftover powder can be used on the tire.



Equipment

Many accessories are available to make cycling safer and more fun, comfortable, and secure. The accessories you choose will depend on where and how you ride. Some of the more popular equipment is described here.

Bicycle Equipment

Racks

Racks are metal or plastic frames attached to the bicycle to help transport objects while riding. They allow you to secure all kinds of gear to the bicycle while keeping your equipment away from the working parts of the bike and off your back, where it could interfere with your balance.

Among the racks available are ones that are mounted on the handlebars, over the front wheel or on the **front fork**, or over the rear wheel. Most bicycle bags have hardware that firmly attaches them to the frames, but bags containing small items and other bulky things can also be secured to frames with bungee cords and straps. Note that the higher a rack is installed on a bicycle, the less weight it should carry. One frame in particular, the low-rider rack, allows the cyclist to carry a bag on either side of the front wheel, keeping the weight low on the bike and the bike in balance.

Bags

The best way to carry gear while cycling is in bags specifically designed for bikes. Most are constructed to hold gear securely and can be mounted on a rack. Many bags have lightweight internal frames that give them shape and keep the bags from sagging into moving parts of the bicycle, interfering with its safe operation. Quick-release fasteners let you remove the bags with ease.

The safest and easiest way for a cyclist to carry extra equipment is to let the bike haul it.

Handlebar bags are great for holding items you need quick access to, like cameras, but such bags should carry as little weight as possible because they are so high on the bike. Seat bags that attach behind and below the saddle are the best place to carry a spare tube, patch kit, lock and cable, and emergency tools. Rack trunks or rear duffel bags are rectangular-shaped bags that attach to a bike's rear rack. These are useful for carrying gear for day trips. Panniers are the bags that hang vertically on front or rear racks on either side of the wheels. These are used to carry more gear for multiple-day rides and tours. Frame bags are thin, triangular bags that can substitute for a seat bag. These fasten between the top tube and seat tube of the bicycle.



Locking devices

Water Bottles and Cages

Water-bottle cages permit the rider to carry fluids conveniently on the bicycle, in plastic bottles sized to hold up to about a quart of liquid. The cages usually are mounted on the seat tube or downtube using special clamping bands or are fastened with machine screws to special threaded sections of the frame. These accessories allow a rider to get a drink quickly with little effort.

Locking Devices

All riders should have some means of preventing the theft of their bicycle. A padlock on a coiled cable is one of the simplest solutions. Locks specifically designed for bicycles also are available. Always secure your bike to a sturdy parking rack or some other immovable object like a tree, pole, or lamppost in a way that does not interfere with other people's movements around your bike. If you ride by yourself, you will need your own locking equipment. Group riders often can share locking devices.

Pumps

A pump is a necessity when you have a flat tire. The long pumps available for road use are mounted directly under the bike's top tube. Minipumps and carbon dioxide tire inflators also are either stored on the bike in their own clip or carried in a seat bag.

Before you go on a ride and need to use a pump, make sure it can inflate the tires of your bike. Make sure, too, that the inflation head is compatible with the type of valve assembly on your bike. Unless you carry a special adapter, a Schrader pump will not work on a Presta valve, and vice versa.

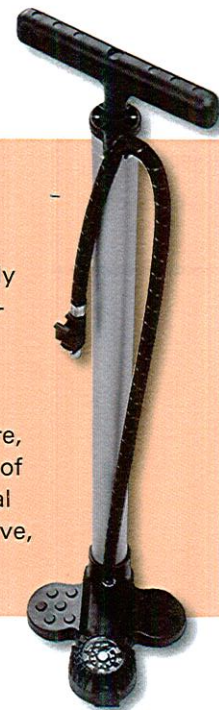

Besides using lights and reflectors, apply reflective tape wherever practical on the bicycle, your clothing, and your helmet. This helps other vehicle operators see you in low-light conditions, especially at dawn and dusk.

Lights and Reflectors

Common sense tells us not to ride at night. If you must ride at night, however, you need lights and **reflectors** to allow people to see you, and for you to see the roadway. Even if you are biking in an area with streetlights, you still need lights to ride in the dark. The better, higher-powered lighting systems provide enough light to let you see the road well in dark areas. In all cases, lights and reflectors should be aimed in the horizontal position to be most effective. When you are riding, do not forget to carry spare lightbulbs and batteries.

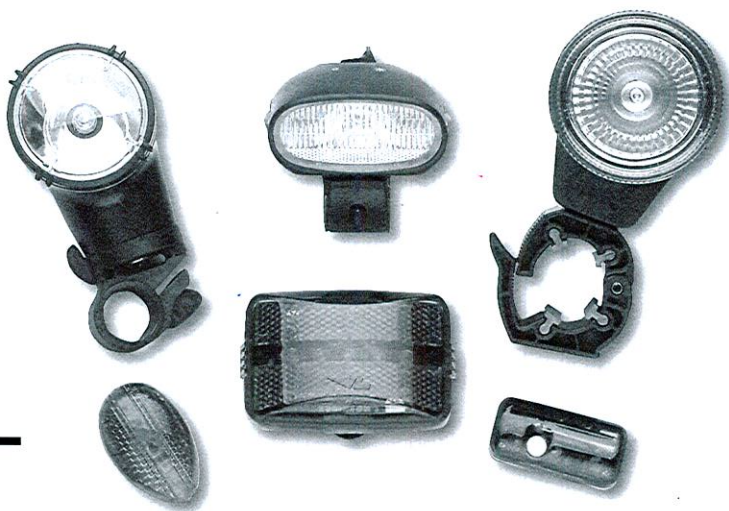

All cyclists in all states are required to use a white front light on their bicycles from sunset to sunrise. Depending upon the state, you also will need either a red rear taillight or a red rear reflector. Some states also require white or amber side reflectors. Check the laws of your state for requirements for lights and reflectors. A bike shop can help you select these components.

For cycling in low light or darkness, you can select from four main types of lights:

1. **Small battery-powered lights** work well for riding in areas with streetlights and can be used with rechargeable batteries, keeping operating costs low.
2. **Generator systems** emit enough brightness to be used on dark roads and go dark when you stop riding.
3. **High-powered battery lights** work well in all conditions but have heavy battery packs and cost more and need more frequent recharging than other types of lights.
4. **High-intensity/high-efficiency front lights with rear strobe lights** can be fastened with Velcro to helmets or clothing.

Mirrors

The cyclist's rearview mirror alerts the rider to vehicles approaching from behind.

Remember, using a mirror is no substitute for scanning by turning your head and making visual contact with everything around you.



Mirrors can be mounted several ways on the handlebars. Several styles of small mirrors attach to glasses or helmets. Although small, these mirrors provide a wide field of view.

Rider's Equipment

Helmets

About 75 percent of the deaths and permanent disabilities resulting from cycling accidents involve brain injuries. A helmet is the most important piece of equipment a cyclist can own.

To protect the head, a helmet must do two things:

1. Gradually slow the momentum of the skull and act as a shock absorber. A good helmet should have a lining of rigid, crushable foam at least half an inch thick. This reduces the severity of damage to the brain when it bangs against the skull when the head hits a hard surface.
2. Prevent sharp items from reaching your head. To do this, a helmet should have a shell covering a layer of crushable foam. The shell distributes the impact of a sharp or hard object over a larger surface, reducing the chance of penetration. Helmets with fabric covers do not provide the protection of shell-covered helmets. Shell-covered helmets can slide along the road surface in an accident, while fabric-covered versions tend to grab on the surface and could twist the rider's neck.

A helmet that has passed the tests for how well it protects will have stickers inside the shell saying that, according to its manufacturer, it meets specifications of the American National Standards Institute (ANSI), the Snell Memorial Foundation, or both. Use only helmets that carry one or both of these stickers.

Select a shell-covered helmet that closely matches the size of your head and is comfortable. Most helmets come with a selection of replaceable pads of various thicknesses. Use these pads to fit the helmet to your head.

The helmet should have four fully adjustable ear straps. Wear your helmet so that it covers your forehead to just above the eyebrows. Adjust the straps so that the helmet stays in this position on your head. The chin strap should be easy to fasten and unfasten. To increase visibility, select a helmet

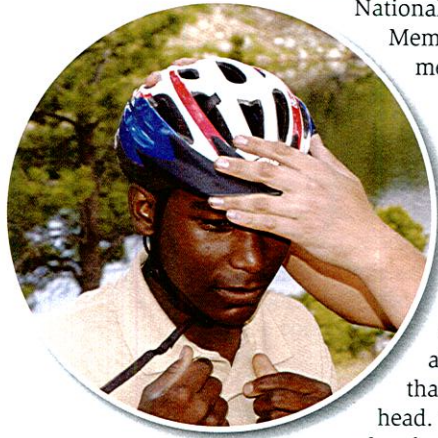

Too far back



Too far forward



Correctly positioned

color that is bright and reflective. You can apply reflective tape or stickers to the helmet to increase your chances of being seen by other vehicle operators. Also, a light-colored helmet will help keep you cool in the hot sun.

Even if it shows no damage, a helmet must be replaced if it has been used in an accident, because the foam protecting the head will have been crushed. The helmet should also be replaced when any of its parts show wear, or if it has been used for more than three years. Compared to your life, a helmet is inexpensive.

Although laws concerning helmet use vary greatly from place to place in the United States, it does not matter whether local laws require the use of a helmet.

Gloves

Gloves serve several purposes. They cushion the shocks transmitted through the handlebars from the wheel, and they reduce damage to the cyclist's hands in the event of a fall. Most gloves have padded palms for cushioning. Warm-weather gloves are fingerless, but their temperature range can be extended by wearing a wool or polypropylene liner under them. Cold-weather gloves cover the whole hand.

Shoes

You can pedal in any comfortable shoes. However, shoes intended for cycling have special features: Usually lightweight, they have very stiff soles to protect your feet. Some cleated shoes have indentations to lock onto **clipless pedals**, and others have reinforced areas where toe clips or straps rub when pedaling.

The rule to remember is: If you are on a bicycle—even straddling it without moving—your helmet should be properly fastened on your head.

Eye Protection

Because a cyclist's eyes are so exposed on rides, they can be stressed and damaged if not protected from the effects of sun, wind, and flying particles or insects. High-quality, polarized sunglasses are recommended. Clear or amber riding glasses or goggles are useful when sun protection is not needed.

Identification

Every rider should carry some form of identification when cycling. In the event of an accident, authorities can use this information to reach the people who should be notified of your situation.

Identification information can be neatly recorded on a card and glued inside your helmet, or stamped into metal dog tags you can purchase. Whatever the form, the information should be carried where someone trying to help can find it easily.



You should carry the following information whenever you are riding:

- Full name
- Home address
- Home telephone number (including area code)
- Date of birth
- Phone numbers of people to contact in an emergency
- Special medical information emergency personnel should know, including any medications you may be taking

Roadside Kit

Be prepared for roadside emergencies by carrying a kit consisting of items such as those shown here.



Registration

Traffic regulations vary by state and locality. When it comes to regulations for bicycles and riders, all states consider bicycles the same as other vehicles. Bicyclists are granted the same rights and have the same responsibilities as operators of motor vehicles—an awesome set of obligations.

Many municipalities have ordinances regulating bicycle registration, inspections, and traffic. Check with your local police department to find out the bicycle regulations in your community.

Many municipalities have ordinances that require residents to register their bicycles with the local police and to show a registration sticker. Depending upon the location, riders might have to pass a bicycle inspection and rider examination to obtain the registration. In this registration process, the police record a complete description of your bicycle, including its serial number. In the event that a lost or stolen bicycle is recovered, this information will enable police to return the bike to you.

Money

A cyclist should carry emergency money on every ride, to be used when strictly necessary. You should carry enough small change for telephone calls and enough paper money to allow you to buy food or drinks when necessary. On many trips you will want to bring other money as well, but it is always nice to know that your backup “cash stash” is available.

Clothing

A cyclist can ride in just about any clothing that is comfortable and does not restrict range of movement.

However, many garments have been designed specifically for cycling.

Jerseys. The cyclist's jersey is a tight-fitting, short- or long-sleeved shirt long enough to cover the rider's waist in the normal riding position. Most have pockets sewn onto the back that allow you to carry food or other small items while cycling. Zippered neck openings let you cool off in warm weather. White or bright-colored jerseys, or fluorescent-colored jerseys let other drivers see you much more clearly.

Shorts. Cycling shorts protect the rider's skin when it is in contact with the saddle. These shorts are made from a stretchable synthetic material and have legs long enough to extend below the edge of the seat. A special material is sewn into the crotch of the shorts to wick moisture away from the area. Cycling shorts come in many colors, but black is most often chosen because it does not show stains from dirty hands, chains, or tires.

Weather-Appropriate Gear

Cycling can be enjoyed year-round if the rider adjusts clothing, bicycle maintenance, and riding techniques to fit the weather. Riding in hot weather requires regular applications of sunscreen and clothes that allow the flow of air to cool your body. Riding in wet or cold weather requires more specialized gear.

Rainwear should be a bright color such as yellow or lime green, and have retroreflective strips to help other drivers see you despite poor visibility. Rain clothing, such as high-tech, breathable-fabric rain jackets or simple nylon windbreakers, should shed the rain and allow air to cool your body, keeping it at a comfortable temperature.



For maximum safety, attach retroreflective strips to your jersey.

Your body controls its temperature by perspiring, so trying to stay dry in clothing that cannot “breathe” will cause your body to overheat and can lead to hyperthermia. Riding unprotected from the rain will cause your body to cool too much and create a serious condition known as hypothermia. (See the chapter called “Riding Skills” for more information on this topic.)

It is important to understand that if you ride in cool or cold weather, your hands, feet, and ears will get cold first. They cannot generate or maintain heat as well as other parts of the body. To warm up, your body needs to transfer heat from warm areas by circulating blood. The clothing you wear—especially gloves and socks—should be loose enough to allow this circulation but tight enough to insulate against the cold. Gloves and socks that are too tight can make hands and feet even colder.

Cyclists can maintain a comfortable body temperature over a wide range of cool and cold conditions by dressing in layers. Experienced riders often will start putting on warmer clothing—long-sleeved jerseys or cycling tights—when the temperatures start to fall into the high 50s. To stay warm on cool or cold days, use multiple thin layers of material that wicks moisture away from the body and keeps you warm even when damp or wet. Wool and polypropylene are two such materials. Thin, closed-cell, neoprene-rubber foam, also used for divers' wetsuits, can be used for gloves, shoe covers, and face masks.

All clothing works better when you can prevent wind from penetrating it and carrying off the body heat you are trying to conserve. Windproof yourself by wearing a nylon shell, windproof ski pants, and wind-resistant glove and shoe covers, which are especially important because hands and feet have the greatest exposure to wind and the least ability to retain warmth.

Your eyes and lungs need protection from the cold, too. Clear or amber-tinted goggles or close-fitting ski-style sunglasses protect your eyes from cold and wind. When temperatures drop below 25 degrees, wear a mask, such as a scarf or inexpensive carpenter's dust mask, over your mouth and nose to prevent lung damage from breathing very cold, dry air.

Do not rely on cotton clothing to keep you warm while cycling; cotton absorbs and retains moisture, actually making you colder as you ride.



Riding Skills

Learning how to ride more safely and efficiently will increase the safety of you and other travelers, in and out of traffic.

Mounting and Dismounting

The mounting and dismounting skills described here use the “pedal-as-step” technique, which will give you maximum control of the bike.

To mount the cycle, hold the brakes to prevent the bike from rolling. Swing either leg up and over the bicycle and stand over the top tube of the frame. Now, lift either your left or right foot and put it in the toe clip of the pedal. If you do not have toe clips, hook your foot under the pedal and turn the crank backward until it reaches the 10 o’clock position.

Let go of the brakes and push down on the pedal. As your body moves up and the bike moves forward, the saddle will move under you. When the opposite pedal reaches the 12 o’clock position, make a second pedal stroke. If you do not manage to get your right foot into the toe clip right away, ride along with the pedal upside down until you get enough momentum to allow you to try again.

To dismount from the bike, place the left pedal straight down and stand on it like a step. Just as the bike is about to come to a stop, lean a little to the right and put your right foot on the ground. As soon as you can, position the left pedal to the 10 o’clock position in preparation for starting again. This way, you are ready for a quick start with minimal effort.

When the pedal is in the 10 o’clock position, you are ready to start pedaling.

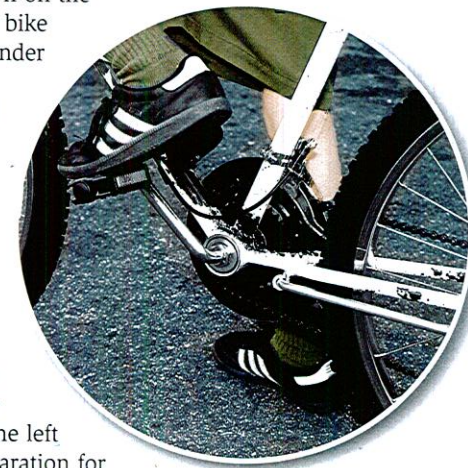

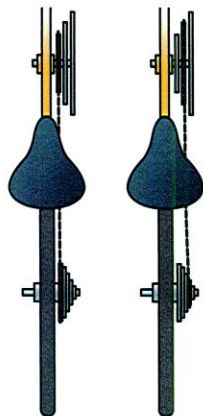

In a pronounced change of terrain, you may need to shift the front derailleur as well as the rear. Move the chain, using the front derailleur/shifter, onto a smaller ring (one closer to the frame) for a lower gear (one in which it's easier to pedal), and, using the rear derailleur/shifter, onto a larger ring (one farther from the frame) for a higher gear (one that enables pedaling as you go downhill).

Braking

To brake efficiently on a bicycle, you must keep your brakes in good operating condition. On a bike equipped with coaster brakes, only the rear wheel and tire provide stopping power. On a bike with hand linear-pull, and disk brakes, both wheels contribute to stopping the bike.

About 80 percent of the stopping force of a bicycle comes from applying the brakes to the front wheel. When a bicycle is stopping, the rider's body weight and the weight of the bicycle shift forward to the front wheel, reducing the weight over the rear wheel. If you apply the front brake too forcefully, you could go over the handlebars. If you use the rear brake too forcefully, it will skid and wear out your rear tire. The trick is to use both brakes together in the most efficient combination.

The most effective way to brake is to use the rear brake as a signal for how hard to apply the front brake. Using both brake levers at the same time, squeeze the front lever three times harder than the rear. Applying the brakes in this 3-to-1 ratio may cause the rear wheel to skid. This skidding is your signal to release the front brake a little bit until the rear wheel stops skidding and the rear brakes resume braking. You can then adjust the pressure on the front brake to limit the braking action on the rear wheel to just before the point where the wheel starts to skid. If you follow this technique, your stops will be safe and efficient.

Shifting Gears

Bicycling is the most efficient means available of turning human energy into forward motion. The gears of a car are shifted to keep the engine turning over within the most efficient range of motion. Similarly, the gears of a bicycle are shifted to keep the legs going at the same rate. In a high gear, your legs cycle slowly and you must push harder. In a low gear, your legs cycle more quickly and you push easily. Cyclists shift gears in search of the combination of gears that lets them go as fast as possible with the least amount of effort.

When climbing hills or riding into a headwind, you change to progressively lower gears to reduce your effort. Going downhill or riding in a tailwind, you change to higher gears to increase your leg effort and maintain your pedaling speed. The more tired you get, the more you should shift to

lower gears. When you think you need to shift to a lower gear, do so as soon as possible. This keeps your leg speed consistent and preserves your momentum.

How to Shift Gears

On a multispeed bicycle, with either internal gears or derailleurs, you can only change gears while you pedal forward. The forward motion either changes the gears in the hub or shifts the chain to different cogs or rings with the derailleur. Just as you move the shifter, slightly reduce the pressure on the pedal until the next gear is fully engaged. This allows for easier shifting with no hard changes that can damage gear-train parts. For safety, shift either the front or the rear derailleur, but not both at the same time.

If your bike has three chainrings in the front, you will do much of your riding with the chain on the middle ring. This means that you have to shift only the rear derailleur to find a comfortable gear. Keep pedaling and use the shifter on the right side of the handlebar or downtube to move the chain.

Rules of the Road

In the words of cycling expert John Forester, "Cyclists fare best when they act and are treated as drivers of vehicles." This means following the same rules of the road that motorists do.

Scanning and Signaling

A key part of following these rules is learning how to observe traffic and making your intentions clear to other drivers. "Scanning" means taking measures to be aware of traffic around you.

Scanning is one way of signaling to drivers that you are looking in their direction because you may want to do something.

Signaling is like asking the question, "May I move from where I am now?" Drivers should respond in some way—by slowing down to let you into the lane, changing lanes to open a lane for you, or actually giving you a signal, as if to say, "Yes, you may move." You must receive the driver's response before changing your riding position on the road.

Mirrors are good for keeping track of vehicle traffic behind you, but the only way you can keep track of vehicle traffic beside you is to look. Do not rely upon your hearing. Cars can be very quiet in motion, and bicycles even more so.

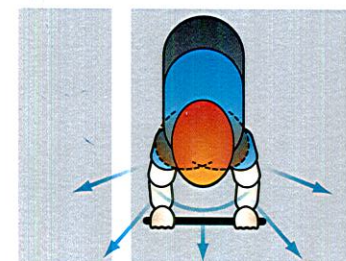

When cyclists turn their head to scan, they often turn the handlebars in the same direction. Practice scanning in an empty parking lot to develop the skill of riding straight without swerving as you turn your head to look.

Although cyclists should signal with the left arm, in heavy traffic, a turn of the cyclist's head can suffice as the only signal in cases where the cyclist must keep both hands on the handlebars, ready to brake if necessary.

Your signal alone does not make it safe for you to change position on the road. One reason is that the vehicles in the other lane have the right-of-way. You must wait for an opening to move into a new lane. If possible, plan your changes early enough to deal with two drivers. If the first driver does not permit your action, the second one most likely will.



Left-turn signal



Right-turn signal



Stop or slow-down signal

Where to Ride

The first rule of the road is: *Ride on the right side of the road, with the flow of all other vehicular traffic.* One of the most frequent causes of car-and-bike accidents is cyclists riding on the left, or pedestrian style, facing the flow of traffic. Riding on the right lets you approach drivers on side streets and pedestrians on sidewalks from the direction they expect, the one from which traffic normally comes. When you ride on the right side of the road, drivers also have more time to react to you and have only to slow down to avoid or pass you.

The standard vehicle code for all road users states, "All persons have an equal right to use the highways for purposes of travel by proper means, and with due regard for the corresponding rights of others." The second rule of the road, then, is: *Slower traffic keeps to the right and faster traffic passes on the left.* A cyclist should ride to the right as far as is safe. Note that the only appropriate time to ride near the edge of the road is when cars are coming from only one direction at a time. In such a situation, cars to the rear can pass you without moving too far into the other lane. If a string of cars is coming toward you on a narrow-lane road, pay close attention: One could pull into your lane to pass.

Keep in mind that riding too close to parked cars makes it hard for you to see around the cars to spot pedestrians, bikes, or cars approaching from driveways or side streets. Also, a car door could open in front of you. Ride 3 feet away from parked cars, hedges, or other obstructions.

You may move slightly toward the center of the road to avoid debris, sand, gravel, or other hazards on the edge of the road.

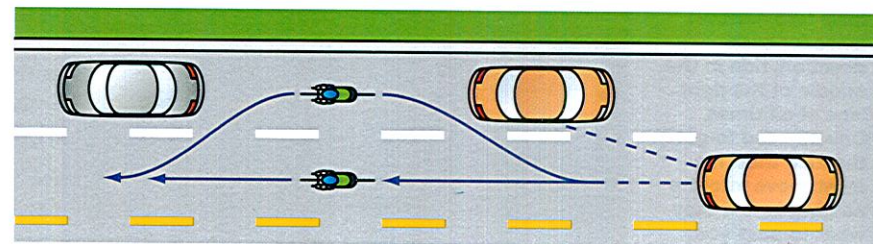

Do not weave among parked cars. You become invisible to drivers and will have to swerve back into traffic when you reach the next parked car.

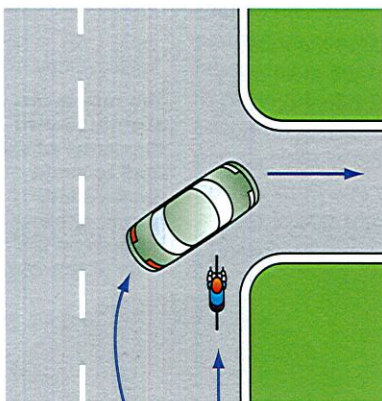

If the roadway has a usable paved shoulder or an extra-wide right lane, you may ride in a line a steady distance from the left side of the right lane and about 3 feet to the right of where the cars are traveling. This lets motorists see you and helps prevent you being cut off by a driver turning right, as in this illustration.

The narrow lanes of country backroads and city streets do not allow a car to pass you without moving to the left, partway into the next lane. On narrow roads with one lane in each direction when cars are approaching you from both directions, and on blind curves where there might be oncoming traffic, take the middle of the lane. Look and signal before you move.

Do not forget that you have the same right to use the road as a motorist. Make motorists slow down for you if the situation warrants it. Be courteous and make a "slow" signal to tell the driver behind you that it is unsafe for them to pass. When motorists approach from the rear, they are required to slow down and follow if they cannot safely pass. As a courteous cyclist, remember not to delay faster drivers unnecessarily.

On roadways that have two narrow lanes for each direction, ride in the middle of the right lane at all times. Drivers need to get the idea that they must move into the passing lane if they want to pass you.

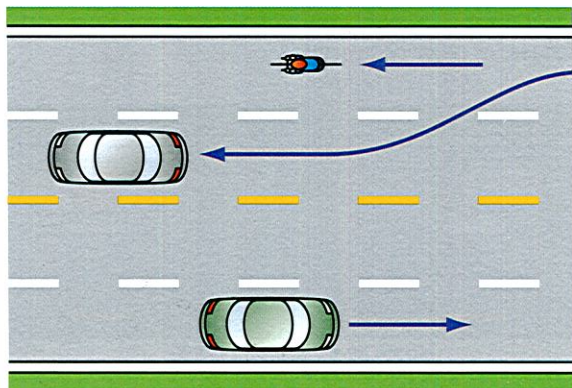

If you are going the same speed as other vehicles, pull into line with them. If you must pass slower vehicles, look back for a safe interval in traffic, and signal before moving left into the passing lane. Drivers expect faster vehicles to pass them on the left. Make sure you are visible to the driver at this point. Do not ride too close to the vehicle you are passing. After you pass, return to the right lane as soon as is convenient. Should the vehicle you are passing speed up while you are beside it, wait until you have fallen behind it, look back to the right for traffic, and merge back to the right when it is safe to do so. Never overtake slower traffic between a moving vehicle and the curb.

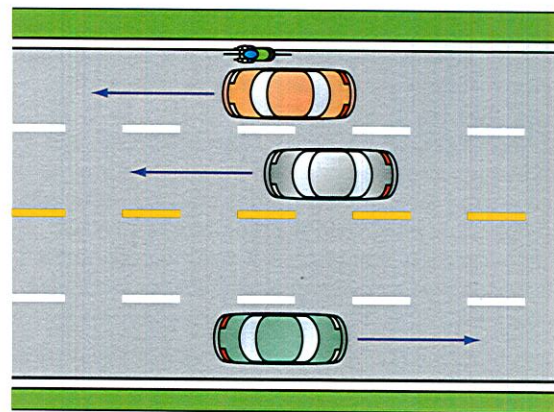

In narrow-lane conditions, riding all the way to the right invites a car to try passing you in the same lane, possibly forcing you off the road.

Handling Intersections

An intersection is any point, including a driveway, where the paths of two vehicles can cross. There are ways to get through an intersection as easily and safely as possible. First, always move to the lane position that will allow you to ride through with the most efficiency. Right-turners get to the right side, those going straight stay near the middle, and those turning left move to just to the right of the center of the roadway or into a left-turn lane.

The cyclist's turning-lanes rules are the following:

- Select the rightmost lane that goes to your destination (the left, middle, or right lane).
- Ride the side nearest your destination if one lane goes to two destinations, such as left and straight through center lanes.

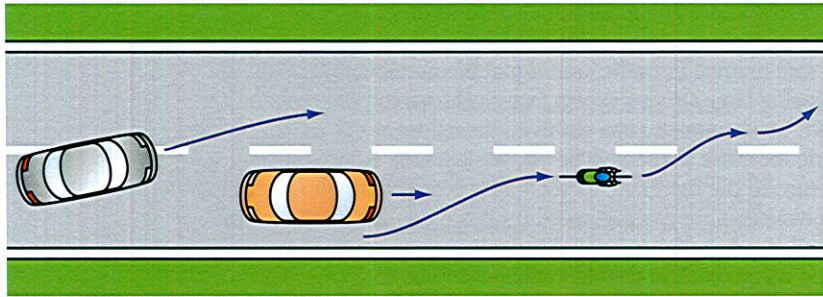

When you are moving into position within a lane, look back for traffic clearance first. When you are changing lanes to get into position, look back to let a driver make room for you, make a left-turn signal, cross to the other side of the lane, look back again to let a driver make room for you, and cross the line into the new lane. To cross multiple lanes, repeat the process as many times as necessary.

Right Turns. Right turns are the easiest turns. From the right side of the right lane, look left and right for oncoming traffic, signal, and go around the corner. At a stop sign or a legal right turn on a red light, you must yield the right-of-way to traffic already in the intersection. You also must yield to pedestrians in the crosswalks. *A right-turn signal is necessary to let drivers know your intentions.*

Left Turns. Left turns are the most complex traffic maneuvers a cyclist can make. Left turns are executed from the center of the roadway, meaning the lane from which no cars on your left will go straight ahead. Turning left from this position puts all the traffic you might have to deal with in front of you. It allows through traffic to pass on your right, and it does not require you to look back when turning.

If the traffic at an intersection is too difficult for you to ride through safely, it is OK to make the left turn as a pedestrian: Ride to the far right corner of the intersection, come to a complete stop, dismount from your bike, and look for traffic in all four directions. Now, wait like a pedestrian until traffic clears, then walk your bicycle safely across the street.

On one-way streets with two or more lanes, you may ride on either side of the road. The easiest way to make a left turn from a one-way street onto another one-way street is to ride around the corner on the left, then change lanes to the right as soon as you are certain the roadway is clear and operators of other vehicles behind you are aware of your intentions.

Going Straight. When going through an intersection, make sure traffic turning right passes you on your right. Ride to the left side of dual-destination lanes (lanes from which vehicles can go straight or right) and stay completely out of right-turn-only lanes. The simplest-looking yet most difficult intersection to ride through is one on a small, two-lane street, where the traffic in the right lane can go left, straight, or right. To discourage drivers from passing you on the left and then turning right, ride a little farther into the lane as you approach the intersection. Finally, position yourself far enough from the curb to allow drivers to make legal right turns on a red light if you are going straight. You might need to gesture to such drivers that it is OK for them to turn between you and the curb.

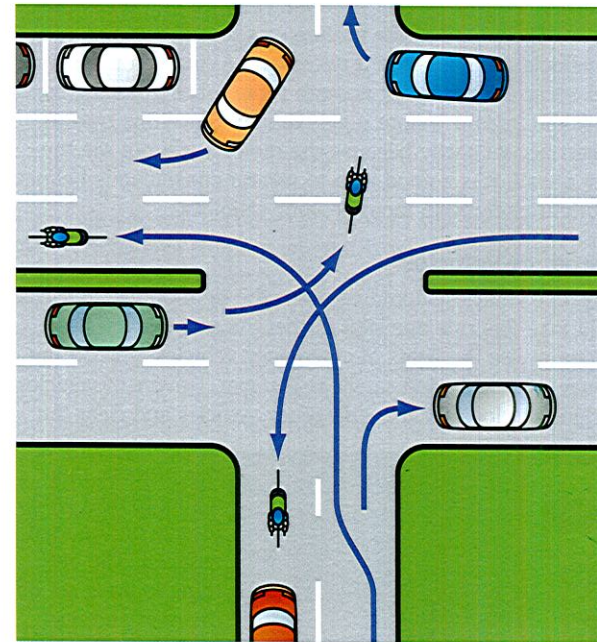

From where in the center lane should you prepare to make your left turn? If the lane is also for through traffic, ride on its left side. If the lane is a left-turn-only lane, ride on its right side. You must yield to other traffic in the intersection—vehicles and pedestrians. Pass oncoming left-turning vehicles right side to right side. When you are turning left from the left side of the lane, do not let left-turning cars behind you pass on the right. While waiting to turn left, move to the middle of the lane and make a slow signal with your left hand to inform the motorists behind you.

Never pass the last in a series of cars stopped and waiting at an intersection. You do not know which way the car will go, or whether it is hiding a pedestrian or other hazard.

Handling Hazards

Motor Vehicles in General

Getting hit from behind on a bicycle happens infrequently, usually when a driver loses control of a vehicle. Because you can do little to recognize or prevent this situation, “heads-up” riding is the only survival strategy you can use. You *can* do something about drivers underestimating your speed and cutting you off in front as they overtake you. While you look ahead, keep track of the passing vehicle through the corner of your eye. If the car merges too soon, slow down to give it space, or, if necessary, take a safe route off the road to avoid it, especially if it is a long vehicle like a bus or truck.

When a string of cars is coming toward you on a rural road, watch for one of the trailing cars to pull out and pass the lead vehicle. Give it space if necessary. A head-on collision could occur if there is not enough room for the passing car to get back in its lane before it gets to you. Since this type of accident occurs partly because the motorist cannot see the cyclist ahead, it is a good idea to wear a conspicuous helmet and bright clothing to increase your visibility.

Emergency Vehicles

Emergency vehicles should be given the right-of-way. Bicyclists should take this rule one step further. As soon as you hear the siren or see the lights of emergency vehicles, pull off the roadway as quickly and safely as you can. Drivers of vehicles are trained to look for the emergency vehicles and clear the

way for them. During this process, their ability to deal with a bicycle on the road is reduced. The best thing to do is get off the road and wait until the emergency vehicles pass.



The general rule for drivers in the presence of police cruisers, fire department equipment, or ambulances is “Sirens or lights, drive right.”

Weather

Generally, you will have to perform more frequent maintenance on your bike when you ride in wet or rainy conditions. Fenders and mudguards can keep the wheels from flinging mud and grit on the rider, and tires with deeper treads can be mounted on the wheels. If your bike has chromed steel rims, you can benefit from switching to anodized aluminum rims. Hand brakes work much better with aluminum rims. The drive train will need to be cleaned and lubricated after every ride through cold, wet weather. Brake pads wear down faster when there is water and grit on the rims of the wheels. Bearings can become contaminated and dirty sooner. Some parts of your bike—such as the drive train—can become inoperative if they get coated with water and freeze. These parts especially require preventive lubrication.

Motor vehicle drivers have a hard time seeing in poor weather conditions. A cyclist’s ability to see others also is reduced. Therefore, ride where you can easily be seen, and do everything else you can to increase your visibility. Remember that rainwear may make it uncomfortable to turn your head to scan and glasses will become rain-spotted and steamy.

Everything gets slippery when it is wet. The roadway loses some traction just by having water on it—especially if it hasn’t rained in a while. Anything made of metal (such as manhole covers, gratings, and steel bridges), painted or wooden surfaces, road markings, and areas on the road where vehicles deposit oil become very slippery. Not only is your ability to brake reduced, but your ability to accelerate or pedal may be affected. The rear wheel may spin out from under you if you attempt to pedal hard, so take it a little easier with the pedals. During wet and cold conditions, watch out for shaded areas on the roadway. Water tends to freeze in these areas, making them very slippery.

Do not ride far away from civilization when a storm is approaching. At the first sign of lightning, find shelter and wait for the storm to pass. If you are riding in cool or cold conditions, plan to take breaks and end your ride at a place where you can get warm and change into dry clothing. Staying in your wet clothes could lead to hypothermia.

Because hand brakes do not work as well in the rain—wet wheel rims prevent the brakes from gripping as well—you will need to squeeze the brakes lightly and regularly to help keep the rims dry so that you can stop quickly when necessary. Allow more room for stopping.

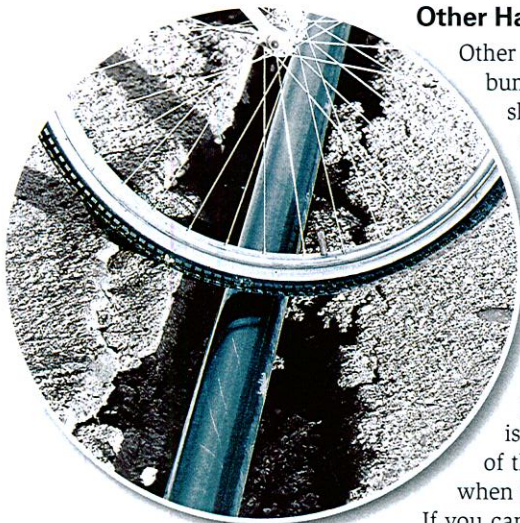

Other Hazards

Other hazards include sharp edges or bumps in the road, diversions, slippery conditions, immovable objects, and moving obstructions. A hazard can be in more than one category. For example, a wet diagonal railroad crossing could be a sharp edge, a parallel diversion, and a slippery surface.

Sharp edges or bumps can cause flats, fold a wheel, or throw you from the bike. The front wheel is more vulnerable to edges because of the weight transfer that occurs when the bike is slowed for any reason.

If you cannot dodge this hazard, try to get the bike to “climb” over it. (Never “climb” curbs.) Cross these hazards at their most level or lowest point. Slowing down gives the wheels more time to climb over without compressing the tire and deforming the rim. You can let the bike pivot under you and reduce the force on each wheel by putting the pedals in a horizontal position just before encountering the obstruction. Stand on both pedals with your arms and legs relaxed and let each wheel climb over independently.

On a bicycle, you have a limited amount of traction, which is divided between accelerating or decelerating, and steering. Slippery conditions reduce traction. This hazard is handled by straightening up and steering straight, or by delaying your braking until better traction is available. *Cross slippery surfaces at right angles, if possible.*

Immovable objects such as concrete barriers are intended to control motor traffic. The only way to handle these hazards, which do serious injury to cyclists, is to watch for them and steer clear.

Almost all road hazards appear in front of the cyclist. Pay attention to everything that is happening in front of you. By being observant and anticipating problems, you can avoid a lot of these hazards. If you cannot avoid a hazard but you can stop safely, get off the bike and walk around the hazard.

Steer your bike carefully to keep moving objects—toys, balls, etc.—and animals and children from getting under your front wheel. If you see a ball, watch out for a child, too. Most animals will get out of your way, but a loose dog can and will chase you. (Dogs usually are only following an instinct to protect their territory.) If this occurs, steer clear of the dog and keep both hands on the handlebars for control. Get the dog behind you, then either try to frighten it off by shouting aggressively or speak to it gently until you get past its property. Shifting to a lower gear and sprinting also is effective. If a dog starts to attack you, get off the bicycle and keep it between you and the dog.

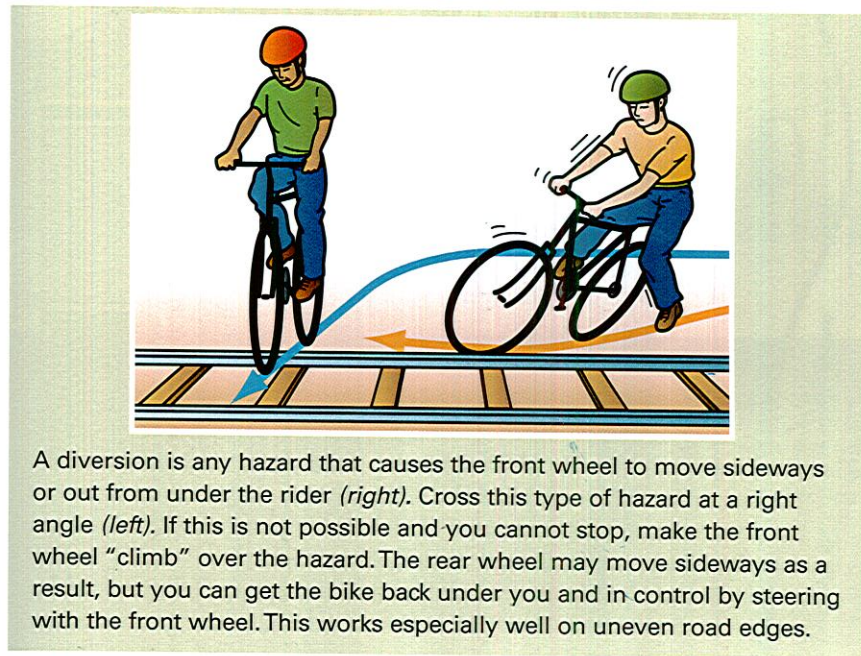

A diversion is any hazard that causes the front wheel to move sideways or out from under the rider (*right*). Cross this type of hazard at a right angle (*left*). If this is not possible and you cannot stop, make the front wheel “climb” over the hazard. The rear wheel may move sideways as a result, but you can get the bike back under you and in control by steering with the front wheel. This works especially well on uneven road edges.

Emergency Maneuvers

The emergency maneuvers described here can be used to handle hazards that occur too quickly for you to use any other measures. Practice these techniques in a safe environment like an empty parking lot or a school playground. These skills do not feel natural; they should be learned and practiced until they come easily. If you must use them, you will not have time to think of how to do them.



The rock dodge makes your wheels weave around a rock or small pothole while you are riding in a straight line. Use the rock dodge when you cannot swerve too far either way because of traffic or the road edge.

The Rock Dodge

Just before you reach the rock or other obstacle, steer the handlebars left without leaning over first. Just as the front wheel goes around the rock, quickly turn the handlebars right to correct your balance and straighten out. This works because your body does not have a chance to follow the weaving of the bike and you have not strayed very far from the line you were originally following.

To practice this technique, place a sponge in the path of your bike and practice missing it. This “practice rock” will not hurt you if you hit it. Start slowly, then increase your speed until you can dodge the “rock” at normal speeds.

The Instant Turn

Picture this: You are approaching an intersection when the car on your left suddenly begins to turn right. You need to turn right, quickly.

You know that to turn on a bicycle, you start by leaning, then steer the handlebars. How do you get the bike into a quick lean so you can turn in a hurry?

The instant turn is like the rock dodge, except that you do not straighten up the last time, and you let the bike stay in the deeper turn. Steer the bike out from under you to the left for an instant. You will momentarily steer toward the car you want to avoid. Now the bike is leaning right and turning. Raise the leg on the inside of the turn and point the knee outward. This will help you deepen the turn. Then, once you are around the corner, bring yourself back up to a vertical position. Practice the instant turn using a sponge. Start cautiously and increase your speed as you learn.

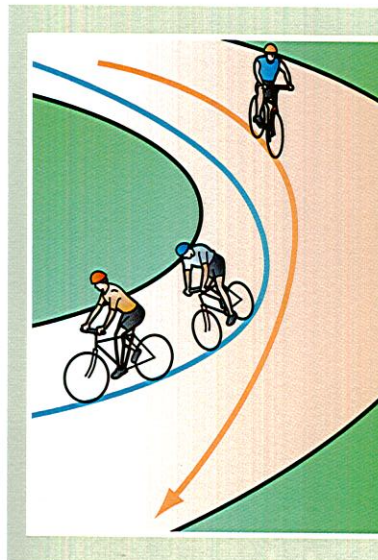
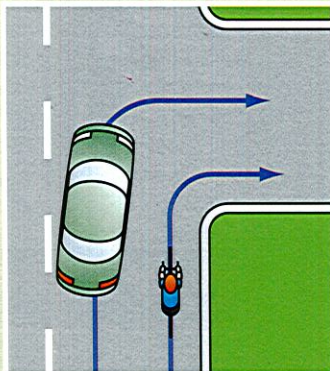

A variation on the instant turn can help if you are going around a downhill curve too fast. Instead of doing what feels right—braking and steering straight—do not brake. Momentarily straighten the handlebars. This should put you into a deeper lean on the bike and let you get around the curve. If you skid out, you will land on your side and skid to a stop. If you are in danger of going over a cliff or hitting a wall, it may be wise to skid on purpose by hitting the brakes after leaning into the turn.

The Panic Stop

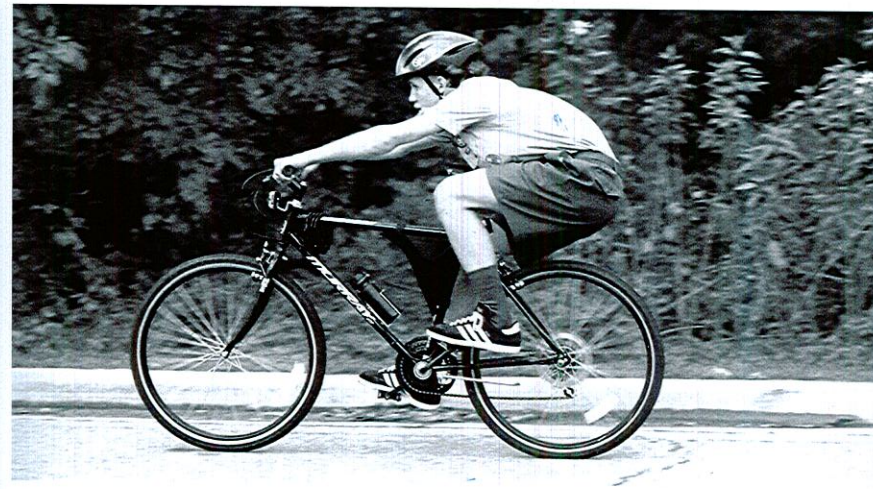

The panic stop is nothing more than a maximum-effort stop without skidding either wheel. You get a gain in braking efficiency when you shift your hips back on the saddle, or even slide off the saddle and place your stomach on the seat. This transfers more of your body weight to the rear wheel and increases its traction.



Touring

Planning the Trip

Many factors must be kept in mind when planning a long bike ride:

- Purpose
- Route
- Distance
- Terrain
- Suitability of roadways
- Traffic conditions
- Weather
- Points of interest
- Starting location and time
- Solo or group ride
- Experience, skill, and condition of riders
- Pace and cadence
- Rest stops
- Eating and drinking

The Route: Maps and Cue Sheets

Maps. When we think of traveling by road, we most often think of our network of superhighways: the monotonous straight lines that mark the shortest distance between two points and increasingly dominate our road maps. Many maps do not even show the little-traveled secondary roads that are really the most interesting and best for cycling. These lesser-known routes run parallel to many major arteries. Turns and twists that repel motorists are the joy of cyclists. They discourage automobile traffic and provide the cyclist with diversion and scenic splendor.

Since these backroads are not always shown on ordinary road maps, cyclists should chart their routes on maps obtained from other sources. Among the best are topographic maps that you can get by writing to the U.S. Geological Survey in Washington, D.C. Similar maps are available from your state's department of conservation or department of public works. County engineer offices stock up-to-date maps of all county

You can avoid getting lost by learning to use a map. The *Boy Scout Handbook* can tell you how to orient a map, locate yourself on it, read the map's symbols, and translate the scale so you know how to gauge map distances on the ground.

roads. Many veteran cyclists consider these the most helpful and readily available. You also can get maps from local bicycle clubs, chambers of commerce, tourism agencies, and nature or conservation groups. Local bookstores are another good source of county maps, atlases, and gazetteers useful for planning rides.

In mapping out your ride, try to plan a return route that is easier than the outgoing route, since you are likely to be less energetic on the return trip. Biking into the prevailing wind going out might give you a tailwind coming back. Hills are also easier in the early part of the route.

Cue Sheets. A cyclist's cue sheet tells how to follow a planned route. Four kinds of information make up a useful cue:

- Mileage—the cumulative distance to the nearest tenth of a mile
- Signals—traffic-control devices, for example:
 - TL (traffic light)
 - SS (stop sign)
 - Y (yield sign)
- Directions/Actions—which way to go:
 - L/BL (left/bear left)
 - R/BR (right/bear right)
 - X/CR (cross)
 - S (straight)
 - TRO (to remain on)
 - RL or R/L (right, then immediate left [jog right])
 - LR or L/R (left, then immediate right [jog left])
- Description—name of the roadway and other useful information

For planning purposes, estimate mileage and indicate signals to the best of your knowledge. On the ride, modify the cue sheet with actual signals and mileage from a cyclometer. If you are the leader for a group of cyclists, you should ride the route ahead of time to make the cue sheet as accurate as possible. This also lets you change the route to handle unexpected difficulties such as roadway construction or closed roads or bridges.

Solo or Group Riding

You can ride alone or with a group of other cyclists. Individual riders have more freedom and choice when selecting the distance, pace, time, and route for a ride. However, solo riders must be self-sufficient. They should have the knowledge, skills, and equipment to take care of themselves on a ride. In terms of safety, riding solo requires extra effort to be visible to other vehicular traffic, by wearing brightly colored conspicuous clothing.

On a trip, riding with others makes the miles seem to fly by because riding with friends is simply more fun. In a group, you can gain the confidence to go farther. Each ride should have a goal. Since individuals want to finish a ride with their friends, they tend to complete the whole ride and not quit early. The individuals of a group do not have to be as self-sufficient because the resources of all the riders—their gear and equipment as well as their experience—can be pooled. For example, only one pump must be carried, and the effort of pedaling can be shared when each person takes a turn at the front breaking the wind, or drafting, for the others.

Group riding has disadvantages, too. The individual riders must follow the same route and maintain the same pace as everyone else. To an extent, you are responsible for everyone else's cycling safety. Each rider has to strive to keep a "safety cocoon" of space—on level ground, three feet to the side, and even more on downhill runs—around his or her bike.

Other safety rules for group riding include:

- Never pass another rider on the right side (your left).
- Never ride two abreast on a winding (curving) or hilly road.
- Never allow the main group of riders to "drop" (lose) slower riders off the back of the group.

Safe group riding requires a lot of communication among riders. The standard hand signals (right turn, left turn, stop) tell riders about changes in direction or speed. Pointing at road hazards is one way to warn others about them. There are also many commonly used verbal signals for warning others of situations.

As the Boy Scouts of America Bike Safety Guidelines states, riders should know that biking with a buddy is best, and "When biking alone, apart from Scout activities, Scouts should be encouraged to tell someone their route, schedule, and destination before departing."

Sample Cue Sheet

Distance	Signal	Action	Description
0.0		L	Locust Street
0.2	SS	R	Sixteenth Street
3.0	TL	L	Bridge Street (becomes Third Street)
2.1	TL	X	Lowther Street
2.5	TL	L	Humel Avenue
4.1	TL	L	Eighteenth Street (becomes Creek Road)
5.7		BL	Lisburn Road (becomes Spangler's Mill Road)
6.7			Caution: metal deck bridge
7.6		L	Limekin Road
8.4		L	Green Lane Drive
10.3	SS	R	Cedar Cliff Drive
11.5	TL	R	Simpson Ferry Road
11.9		L	Elkwood Street
12.0	SS	L	Locust Street
12.0		L	Home

Legend: SS = Stop Sign; L = Left; R = Right; TL = Traffic Light; X = Cross;
BL = Bear Left; BR = Bear Right

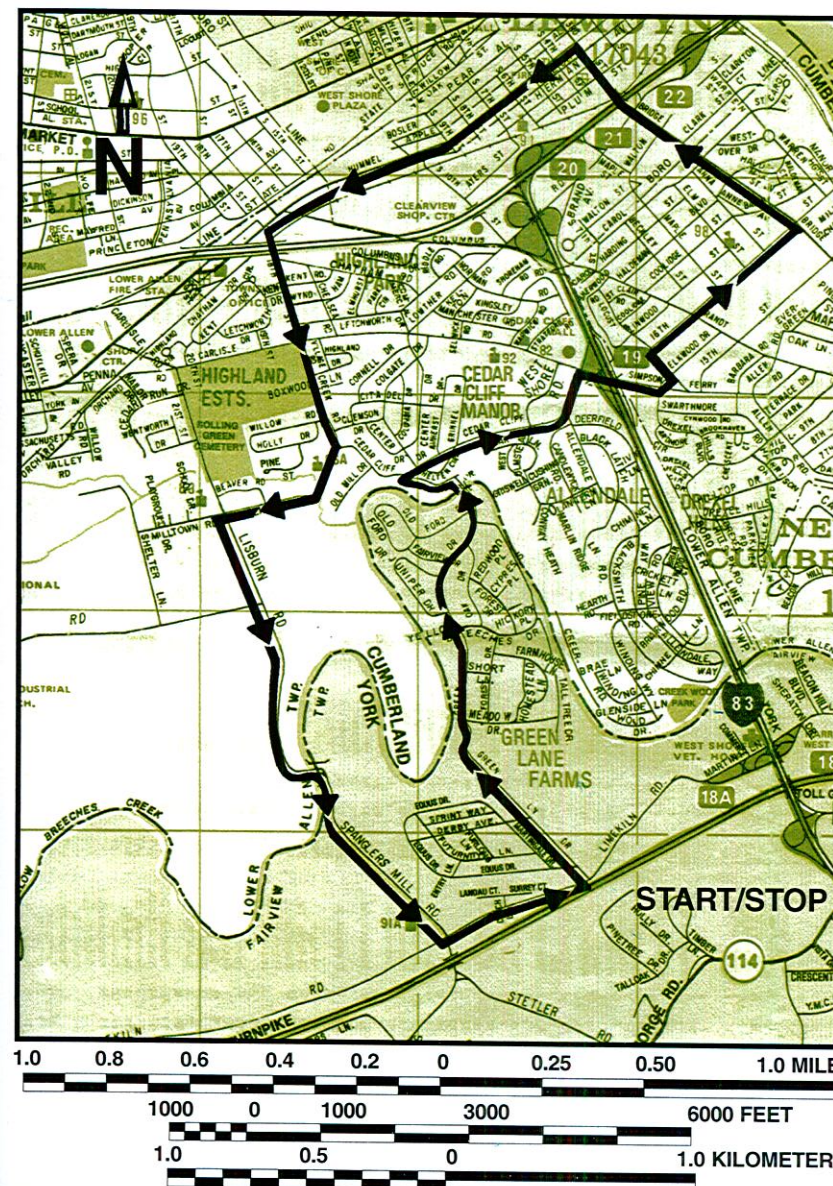

When you are on the same road for a long distance, including a cue that indicates a landmark (for example, a crossroad) helps confirm that you are on the correct route and reduces the chances of taking wrong turns.

Verbal Signals for Warning Others

"Right (left) turn!"—We are making a turn to the right (left).

"Stopping (Slowing)!"—I am stopping or slowing down.

"Coming on!" or "Coming off!"—I'm entering (or leaving) the roadway or trail.

"Gravel!"—There is loose material ahead on the roadway.

"Glass!"—There is glass ahead on the roadway.

"Rumbles!"—There are rumbles (textured strips) on the shoulder of the road.

"Tracks up!"—There are railroad tracks ahead.

"Grate!"—There is a storm grate ahead. (Storm grates can catch wheels and cause falls.)

"Car left (right)!"—A car is approaching from the left (right).

"Car back!"—A vehicle is approaching from the rear. Form a single line as quickly and safely as possible.

"Car up!"—A car is approaching from the front.

"On your wheel!"—I am directly behind you.

"Roadkill!"—There is a dead animal ahead in the roadway.

"Thank you!"—OK/I heard you.

Cadence and Pace

You will have more fun on a bike trip if you understand the importance of moderation and common sense in setting the pace.

Cadence, or pedal speed, is the number of times the pedals complete a full revolution per minute (rpm). Experience has shown that the best cadence for riding longer distances is 75 to 95 rpm. This cadence may feel strange and uncomfortable to you in the beginning; however, practice riding at this cadence and you will find that you can go longer distances with greater ease. Pedaling at

a low cadence will increase your fatigue. Experienced cyclists frequently pedal at cadence levels between 95 and 105 rpm or higher.

Automobiles measure their speed in miles per hour. Cyclists frequently do the same. If you have a cycle computer,

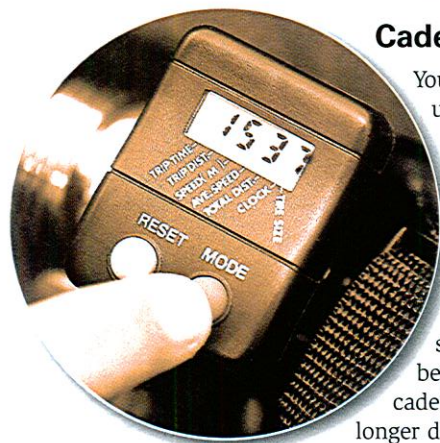

A cadence monitor on a cycle computer can tell you when you have reached the desired rpm.

it is tempting to begin your ride at a faster pace than advised—you are fresh, you have lots of energy, and it feels good. However, remember how many miles you expect to travel that day or for that trip. Plan to travel at an average pace of 10 to 12 miles per hour for the entire trip, realizing that you will climb hills at a slower pace and go down hills at a faster one. Realize also that riding into the wind, even on flat land, will be as difficult as, if not more difficult than, pedaling up a long, steep hill. Strong winds blowing across the road could throw the unsuspecting cyclist off balance.

The best part of cycling is the opportunity to see the world around you. In an automobile, the scenery rushes by. Traveling by bike lets you experience things you might otherwise hardly notice. This is why it is best to set a realistic pace, take rest stops when you feel like it, and enjoy the scenery and your riding companions.

Other Considerations

Staying Comfortable

To ease muscle aches from being in the same position on your bike for several hours, vary your riding position. Move your hands to different places on the handlebars. Remember to keep your elbows flexed. Stiff, rigid elbows will cause fatigue in your hands, shoulders, and back.

Too much sun can cause sunburn and skin damage. Always use sunblock to protect any skin not covered with clothing. Do not forget the tops of the ears, the back of the neck, and the nose. Lip balm should also be applied to the lips for protection.

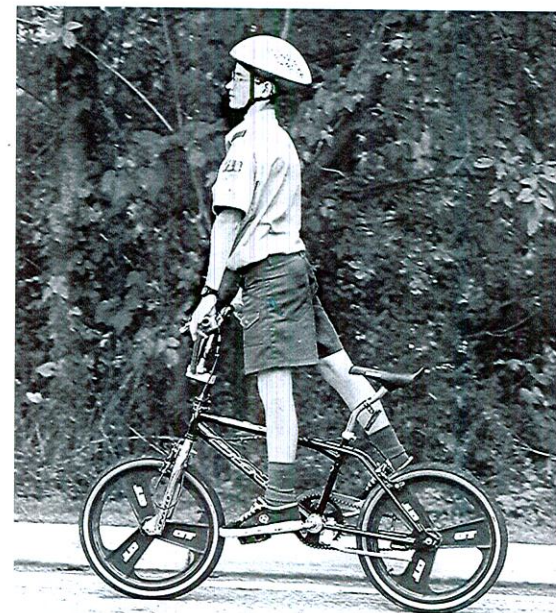

Stretch while riding. Every 30 minutes, stand on the pedals, arch your back, and stretch your legs. To prevent upper-body stiffness, do slow neck rolls and shoulder shrugs. When you are out riding, practice stretching so that you will be able to do so effectively on longer rides.

Stops

There are lots of reasons to stop on a ride: to eat and drink; to take photographs or view points of interest; to allow stacked-up motorists to pass on narrow roads; to fix mechanical problems such as flat tires; to rest; and to let slower riders rejoin the group. In this last situation, do not resume the ride immediately when the slower riders catch up. The cyclists who just rejoined the group should determine when to resume the ride.

The best place to stop is where all riders can get a safe distance off the roadway. Stops should not be made in places that interfere with the movement of other vehicles or pedestrians. Riders should be visible from a long distance by motorists. It is more enjoyable to start down a hill after a rest, so try not to stop at the bottom or in the middle of a hill. Again, do not remain on the roadway while stopped.

Nutrition

Food provides the energy necessary for cycling. All foods are composed of carbohydrates, fats, and protein. Carbohydrates are the primary energy source for recreational cycling. Fats, also an energy source, are more important in endurance sporting events (such as track and field events or long-distance marathon running). Proteins maintain and repair cells throughout the body.

There are simple and complex carbohydrates, or “carbs.” Simple carbs, also called sugars, are found in fruits and vegetables, provide quick energy, and are not stored by the body to maintain energy. Complex carbs, also called starches, are found in pasta, breads, and cereals. Complex carbs provide the long-term energy to fuel you through a long bicycle ride. A meal of pasta should be consumed the day before you venture out on your bike ride. A breakfast of complex carbs (cereal and a bagel or English muffin) will provide a good energy foundation the morning of your ride.

The basic rule of refueling while cycling is: *Eat before you are hungry and drink before you are thirsty.*

Try not to stop for more than 10 minutes at a time during your ride. Longer rest stops can make you stiff and zap your motivation.

Fats should be avoided because they are difficult for the body to digest and will rob you of needed energy. Eating a hamburger and french fries, for example, will overload your body with fat. This overloading forces the body to use all of its energy to digest the food rather than to propel your bike.

Proteins are important to the body’s maintenance and repair of cells. Foods containing proteins—such as meats and peanut butter—should be consumed moderately to keep a nutritional balance in your body.

Eating a meal of spaghetti, salad, and bread the night before a long ride will prepare your body appropriately. Fig bars, granola bars, and dried fruits (raisins, apricots, pineapple, etc.) are excellent natural sources of the simple carbohydrates that will keep you going during your ride. Bananas are a cyclist’s mainstay. They provide carbs as well as other vitamins and nutrients that the body uses in large amounts while cycling. Plan to refuel (snack) every 20 minutes, or at least every 10 miles.

You will perspire more heavily than usual while cycling. Dehydration is a serious condition and should be prevented. On the day before you begin your ride, consume more water than usual. This will “superhydrate” your body in preparation for the exertion of the ride. Plan to drink one bottle (about 20 ounces) of water per hour or one bottle every 10 to 12 miles of your ride. If the weather is exceptionally hot and humid, increase the amount and frequency of your drinking. You may want to take along sports drinks, some of which contain the carbs, vitamins, and other nutrients, as well as necessary fluid, to keep you going. However, many of these drinks contain lots of sugar and sodium, so read the labels and choose carefully.

For an enjoyable ride, eat and drink at a slow, steady pace. Your route should include rest stops at regular intervals. If you plan when and what you will consume, you will find that your muscles will enjoy the ride as much as the rest of you will.

If you find yourself feeling light-headed and ill on a very hot day, you may be experiencing the beginning symptoms of dehydration. Get off your bike and get help to rehydrate before continuing your ride.



Mountain Biking

Just as cycling on the road requires the rider to master certain skills and maneuvers, so, too, does riding on public trails. To get started on the right path to mountain biking, be sure to choose the right bike for you.

The Right Bike for the Right Use

There are three basic types of mountain bikes.

Rigid mountain bikes have no front or rear suspension shock absorbers. These bikes are great for bikers with beginner to intermediate abilities because the lack of cushioning makes the rider feel every bump on the trail. Consequently, the rider quickly learns to take the smoothest line of approach. Rigid mountain bikes are typically the least costly to buy and the easiest to maintain. Rigid bikes are designed for smooth to intermediate trails.

Hard-tail mountain bikes have shock-absorbing suspension for the front wheel, but no suspension for the back wheel. Front shocks allow the steering wheel to stay planted on the ground while riding over small bumps and improve overall handling and control. Hard-tail bikes are designed for all abilities, tend to cost more than rigid bikes, and require good mechanical ability to service. Hard tails are best suited for intermediate to rough trail conditions.

Full-suspension mountain bikes use shock-absorbing suspension technology for the front and rear wheels. Shocks on both wheels improve handling and control at higher speeds by helping to smooth out rough terrain. Full-suspension bikes are designed for riders with intermediate to advanced abilities. They are more costly than rigid and hard-tail mountain bikes and are the heaviest of the three. Full-suspension bikes require the most maintenance to keep all moving parts working correctly.



In addition to being courteous and following the bicycle safety guidelines, mountain bikers recognize a few more rules:

- Ride on open trails only.
- Leave No Trace.
- Never scare animals.

Because there are many types of mountain bike frames and accessories, it is best to work with a knowledgeable bike shop to find the combination that fits you best. The only way to tell if a new bike, frame, or accessory fits and functions for you is to try it where you like to ride, the way you like to ride.

Sharing the Path

Perhaps the most important thing you can learn about riding on a public mixed-use path is proper trail courtesy. Remember, when a speeding cyclist hits someone or something, the bicycle rider usually is the more seriously injured party. Respect other trail users, such as walkers, joggers, and in-line skaters. Yield to slower users. Let others know you are approaching.

Sometimes cyclists like to venture beyond the easy trails that also are used by people walking or riding a bicycle leisurely. The narrow mountain trails that crisscross the wilderness are called singletracks. Riding singletrack involves more skill and training than riding flat, wide, mixed-use paths. Some of the most important skills for singletrack riding are navigating rough terrain, climbing, and descending steep hills.

Riding Rough Terrain

Manipulating a mountain bike over rocks, roots, logs, and other trail hazards is an art. Find the path of least resistance with your front wheel and look where you want to go. Keep your weight back and off the saddle, and your arms bent at the elbow. Do not lock up the front wheel by braking too hard.

Keep your grip tight, but your wrists, elbows, knees, ankles, and shoulder joints relaxed. Your arm muscles should be as relaxed as possible, too, while still controlling large movements of the front wheel from side to side and up and down. Your leg muscles must also remain relaxed while still providing the necessary power to the pedals. This allows your body to act as a shock-absorbing system.

Take more weight off the front wheel when riding over obstacles. The trick is to maintain directional control while flowing over any and all obstacles.

Four Tips to Improve Steep Climbs

Having the right strengths and, more importantly, the right skills for climbing a steep hill separates the skilled mountain biker from the beginner. Any hill can be a challenge depending upon your experience, your bike, how tired you are, and the kind of surface you are riding. Steep hills expose the limits of your equipment, technique, and fitness level.

You can work on your technique more easily when climbing, because you are moving more slowly. Maintaining your balance becomes very important at slower speeds. Since the wheels are no longer spinning quickly, you do not have the gyroscopic effect to help keep you upright.

1. Shift Weight Forward.

When entering a steep climb, shift your weight forward. This helps improve control and keeps the front wheel on the ground. Shifting to the lowest or one of the lowest gears prior to starting the climb makes the effort easier on you and your bike.

2. Lower Your Center of Gravity.

When climbing a steep hill, move forward onto the tip of the saddle, bend your elbows down, and lean toward the handlebars. Relax your upper body and keep a firm grip on the handlebars. This will lower your center of gravity, stabilize your balance, and improve traction to the rear wheel, making climbing much easier. Do not stand up on the pedals during steep climbs. Standing will shift your weight too far forward and you will lose rear wheel traction. Staying seated is the best position for steep climbs.

3. Pull Down and Back Against the Handlebars.

Drop your wrists and bend your elbows. Pull down and back against the handlebars. Timing the pull of your hand against the push of the pedal stroke helps improve traction.

4. Stay Smooth.

Do not rock your upper body from side to side; keep your hips steady on the seat. Leaning to one side reduces traction. Do not waste your energy. Keep your breathing steady.

Four Tips for Steep Descents

One of the great joys of mountain biking is the exhilaration of riding downhill, particularly a steep hill. Singletrack skills must be practiced many times before they become second nature.

Never ride down a steep hill or trail without knowing if the trail is open to bikes and if other trail users such as hikers, horseback riders, hunters, or all-terrain vehicles are allowed to use the same trail. Never ride on trails closed to mountain bikes, no matter how tempting it may be.

Steep slopes (20 percent grade or more) will erode and change when exposed to rain, wind, and trail users. Bicycling professionals would not think of riding a new section of downhill singletrack without first inspecting the trail. Never be afraid to walk down a hill that is inappropriate for you because of unusual weather, the wrong equipment, or the need for more practice. Always have a place to make an emergency stop on a new hill.

1. Be Ready at the Start of the Hill.

Put your bike in the highest gear of your chainrings and in the middle gear of your cassette (on the rear axle). Keep your feet horizontal to the ground to minimize contact between the pedals and rocks or logs. When the terrain permits, pedal to increase downhill speed if desired, returning to the parallel-to-the-ground position quickly.

A tough hill calls for secure handholds on the handlebar with just a finger holding the brake levers. Remember that bent elbows and relaxed arm and leg muscles act as shock absorbers, reducing wear and tear on the body.

2. Start Slowly.

The steeper the descent, the slower you should start your ride. Once you have started downhill in earnest, you may find it very difficult to slow down. Sometimes brakes become ineffective on steeper hills, especially where there are loose rocks, gravel, or dirt.

Grooves caused by water runoff or previous riders should be avoided. If you find yourself in a groove, try not to brake suddenly as it will not help you slow down, but will only make the groove worse. Weave from side to side until you find firmer ground.

The faster you are traveling, the farther you should look down the hill to anticipate avoiding or riding over tree limbs, rocks, and other obstacles. Part of the art of downhill riding is picking the best "line," or most enjoyable ride.

3. Keep Your Weight Back on the Bike.

Slide back on the bicycle. Sometimes you may end up with your arms fully extended and your rear over the back wheel, just as in the emergency stop on the road described in the "Riding Skills" chapter. Do not move your weight back that far, however, unless you are on a steep hill, and not too fast even then or you will lose control over the front wheel.

4. Avoid Skids.

Do not brake too hard with the rear brake or you will lock the rear wheel, causing it to slide along the surface, as well as damage the trail. If your rear wheel starts to skid, let up on the rear brake.

Under extreme conditions, even the front wheel will skid. The same trick for stopping the rear wheel from skidding works here, too—just let go of the front brake a bit. The front brake is doing most of the stopping, however, so be prepared to reapply the front brake almost immediately. If you still skid, turn in the direction of the skid so that you do not fall.

Other Skills

That is just the tip of the mountain when it comes to single-track. Still to be learned are wheelies and plenty of other moves that will make every mountain bike experience unique. Beyond mountain biking, other types of off-road cycling sports may intrigue you, too, such as free riding, cross-country, and downhill racing. The best way to find out more about any form of off-road riding is to find experienced groups in your area. To learn more about any of these off-road sports, visit the Web sites for the cycling organizations listed in the resources section of this pamphlet.

Cycling and First Aid

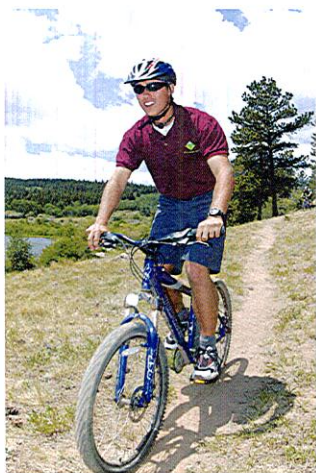

While cyclists can prepare for their rides by keeping their bodies and bikes fit and by planning their routes, sometimes first-aid situations will arise, and all riders should be prepared to take action.

Hypothermia

Hypothermia occurs when a person's body is losing more heat than it can generate. Exposure to the cold and dehydration are a couple of contributing factors to hypothermia. Wind, rain, hunger, and exhaustion can further compound the danger. Temperatures do not need to be below freezing, either. A biker caught out in a cold, windy rain shower without proper rain gear can be at great risk. A hypothermia victim may experience numbness, fatigue, irritability, slurred speech, uncontrollable shivering, poor judgment or decision

making, and loss of consciousness. After calling for help, use any or all of the following methods to help rewarm the person.

- If fully conscious and able to swallow, have the person drink warm liquids (soup, fruit juices, water; no caffeine or alcohol).
- Move the person to a shelter. Replace wet clothing with dry, warm clothes or wrap the person in anything handy like jackets or a sleeping bag.
- Wrap towels around water bottles filled with warm fluid, then position the bottles in the armpit and groin areas.

Monitor a hypothermia victim closely for any change in condition. Do not rewarm the person too quickly (for instance, by immersing the person in warm water); doing so can be dangerous to the heart.

Frostbite

Frostbite occurs when skin is exposed to temperatures cold enough that ice crystals begin to form in the tissues. The ears, nose, fingers, or feet might feel painful or numb, though the person may not notice any such sensation. Grayish-white patches on the skin signal the first stage of frostbite, or frostnip. To treat frostbite, remove wet clothing and wrap the injured area in a dry blanket. Get the victim under the care of a physician as soon as possible. Do not massage the area or rub it with snow.

Rewarm the area only if there is no chance of refreezing.

Expose the area to warm (100° to 105° F) water until normal color returns and it feels warm. Bandage the area loosely with dry, sterile gauze between fingers and toes. To treat frostnip, move the victim into a tent or building, then warm the injured area. To rewarm an ear or cheek, remove a glove and cover the area with the palm of your hand. Slip a frostnipped hand under your clothing and tuck it beneath an armpit. Treat frostnipped toes by putting the victim's bare feet against the warm skin of your belly.

Dehydration

When we lose more water than we take in, we become dehydrated. Symptoms of mild dehydration include increased thirst, dry lips, and dark yellow urine. Symptoms of moderate to severe dehydration include severe thirst, dry mouth with little saliva, dry skin, weakness, dizziness, confusion, nausea, cramping, loss of appetite, decreased sweating (even with exertion), decreased urine production, and dark brown urine. For mild dehydration, drink a quart or two of water or sports drink over two to four hours. Rest for 24 hours and continue drinking fluids. See a physician for moderate to severe dehydration, which requires emergency care; the victim will need intravenous fluids.

Dehydration increases the danger of frostbite, so be just as diligent about drinking fluids in cold weather as you are when the weather is hot. Drink before you feel thirsty—thirst is an indication you are already becoming dehydrated.

Heat Exhaustion

Heat exhaustion can be brought on by a combination of dehydration and a warm environment. Symptoms include a severe lack of energy, general weakness, headache, nausea, faintness, and sweating; cool, pale, moist skin, and a rapid pulse. To treat heat exhaustion, get the person in a shady, cool spot. Encourage the victim to drink small amounts of fluids, such as cool water or a sports drink. Apply water to the skin and clothing and fan the person. Raising the legs may help prevent a feeling of faintness. Usually after two or three hours of rest and fluids, the victim will feel better but should rest for the remainder of the day and be extra careful about staying hydrated.

Heatstroke

In heatstroke, the body's cooling system begins to fail and the person's core temperature rises to life-threatening levels (above 105 degrees). Dehydration and overexertion in hot weather, especially in high humidity, can lead to heatstroke. Symptoms can include any symptoms of heat exhaustion as well as hot, sweaty, red skin, confusion, disorientation, and a rapid pulse. If you suspect someone is suffering from heatstroke, call for medical assistance immediately. Then quickly work to lower the victim's temperature. Move the person to a shady, cool area. Loosen tight clothing, fan the victim, and apply wet towels. If you have ice packs, wrap them in a thin barrier (such as a T-shirt) and place them under the armpits and against the neck and groin. If the person is able to drink, give small amounts of cool water.

Hyperventilation is the result of overbreathing, either deliberately or as a result of panic. Hyperventilating decreases the level of carbon dioxide in the blood and suppresses the breathing reflex. The victim can feel dizzy, faint, and numbness, tingling, and cramping in the fingers and toes. If a biker becomes panicky, stop the biking activity and calm the person. Before resuming any activity, determine and resolve the cause of the panic.

Blisters

Blisters are pockets of fluid that form when the skin is aggravated by friction. A hot spot—the tender area as a blister starts to form—is a signal to stop immediately. To help prevent foot blisters, wear shoes or boots that fit, change socks if they become sweaty or wet, and pay attention to how your feet feel. To help prevent blisters on the hands, wear gloves for protection and pay attention to how your hands feel. To treat a hot spot, cover the pinkish, tender area with a piece of moleskin or molefoam slightly larger than the hot spot. Use several layers if necessary. If you must drain a blister, wash the skin with soap and water, then sterilize a pin in the flame of a match. Prick the blister near its lower edge and press out the fluid. Change bandages every day to help keep wounds clean and avoid infection.

Diabetics who develop blisters should see a physician.

Bites and Stings

Ticks. To avoid getting bitten by ticks, wear long pants and a long-sleeved shirt whenever you are in tick-infested woodlands and fields. Ticks bury their heads beneath the skin of their victims. To remove a tick, with gloved hands, grasp it with tweezers close to the skin and gently pull until it comes loose. Don't squeeze, twist, or jerk the tick, as doing so could leave its mouth parts still buried in the skin and may cause the tick to release more of any disease-carrying bacteria. Wash the wound with soap and water and apply an antiseptic. Thoroughly wash your hands after handling a tick.

Fire ants. The sting of a fire ant can be extremely painful. Be careful not to break the tiny blisters that form from the stings. Wash the area well using antiseptic or soap and water. Cover with a sterile bandage. For relief, try a paste made of baking soda and water, and take a mild nonaspirin pain reliever.

Bee, wasp, or hornet stings. If you are stung by a bee, wasp, or hornet but are not allergic to their stings, simply remove the stinger by scraping it out with a knife blade. Don't try to squeeze the stinger out. Doing so will force more venom into the skin from the sac attached to the stinger. Use an ice pack to help reduce pain and swelling.





For the few people who are allergic to bee or wasp venom or fire ant bites, these injuries can cause a life-threatening reaction called *anaphylactic shock* (*anaphylaxis*). Symptoms can include a swelling of throat tissues or tongue that makes breathing difficult or even impossible. Any Scout who has an allergy that could cause anaphylactic shock should share that information with his unit leaders and let them know where anaphylaxis medications are kept so that they can be made available at a moment's notice.

Snakebites. The nonvenomous snakebite causes minor puncture wounds and can be treated as such. Scrub the bite with soap and water, apply an antiseptic, and cover with a sterile bandage. However, the bite of a venomous snakebite requires special care.

Step 1—Get the victim under medical care as soon as possible so that physicians can neutralize the venom.

Step 2—Remove rings and other jewelry that might cause problems should the bite area swell.

Step 3—If the victim must wait for medical attention to arrive, wash the wound. For a coral snakebite, wrap the area snugly (but comfortably) with an elastic roller bandage.

Step 4—Have the victim lie down and position the bitten part lower than the rest of his body. Keep him calm and assure him that he is being cared for.

Step 5—Treat for shock.

Do not give the victim alcohol, sedatives, or aspirin. Do not apply ice to the snakebite. Ice could damage the skin and tissue. Do not make any cuts on or apply suction to the bite, apply a tourniquet, or use electric shock such as from a car battery. These methods could cause more harm to the victim or are not proven to be effective.



Rattlesnake



Coral snake



Cottonmouth
pit viper

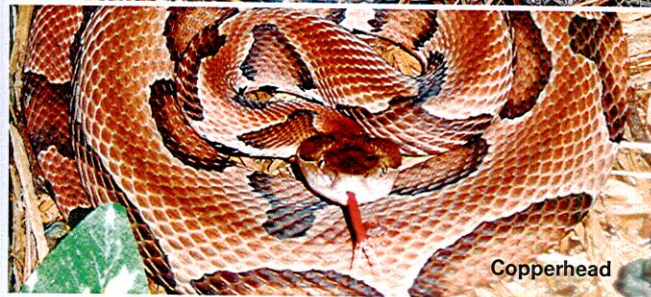

Copperhead

The venom of a coral snake works on the nervous system. Signals of a coral snakebite include slowed physical and mental reactions, sleepiness, nausea, shortness of breath, convulsions, shock, and coma. Pit vipers include rattlesnakes, copperheads, and cottonmouths. These snakes have triangular-shaped heads with pits on each side in front of their eyes. Their venom affects the circulatory system. Signals of a pit viper bite include puncture marks, pain and swelling (perhaps extreme), skin discoloration, nausea and vomiting, shallow breathing, blurred vision, and shock.

Improving as a Cyclist

The Cycling Journal

A cycling journal is essential to improving your riding. Keeping a journal will enable you to gauge your progress, help you to recognize why on certain days riding felt exceptionally good, and let you build on the unique experiences you have. It also will give you material for the reports you need to write to fulfill requirement 8 of the Cycling merit badge.

Mileage and Experience

Keep a steady record of the mileage you complete each time you go for a ride. You may find that 10 miles is long for a beginning ride. Start your journal, however, with the first ride you take, regardless of the length. Then, ride five miles one day and five miles another day in the same week.

You need not take a trip to accomplish this.

Do you know the length of your street?

Ride up and down your street continuously until you have completed five miles. The next week, repeat the process, except this time, ride seven miles at a time.

In your journal, record also what you eat and drink every day, especially what you eat and drink while riding. As your mileage per ride increases, you will find that certain foods and drinks will fuel you more comfortably for a long ride. Your journal will help you clarify what you enjoyed about each ride and help you isolate things that you would like to do differently on your next ride.



Sample Journal Entry

Date: _____ Hours slept: _____

Nutrition: (Record what you ate for each meal and snacks.)

Breakfast: _____

Lunch: _____

Dinner: _____

Snacks: _____

Distance ridden today: _____

Route and type of terrain: _____

Weather: _____

Remarks: _____

Use your journal as notes for the reports you write for requirement 8.

Appendix

Bicycle Safety Checklist

Use this list, or another provided by your counselor, to be sure your bike is ready for inspection—and the road or trail.

- Frame (1)**—Clean and not bent out of shape. No cracks at frame joints (2).
- Front fork (3)**—Clean and not bent out of shape. No cracks at fork joints (4).
- Headset bearing (5)**—Well lubricated; turns freely with no binding. No perceptible play in the assembly.
- Bottom-bracket bearing (6)**—Turns freely with no more than barely perceptible play in the bearing.
- Crankarms (7)**—Clean and not bent out of shape. Tightened securely on the crankset axle (8).
- Chainrings (9)**—Clean, not worn, and not bent out of shape. Chainring bolts (10) tightened securely to hold chainrings to crankarms.
- Pedals (11)**—Bearings well-lubricated; turn freely with no perceptible play in the bearing. Pedals tightly screwed into crankarm. Toe clips (12) or clipless pedals functional.
- Wheels (13)**—Run true and round. Wheel nuts tight. Closed and tight quick-releases (14). Centered in fork or frame members.
- Wheel bearings (15) in hubs**—Well lubricated and properly adjusted to move freely with no more than barely perceptible play.
- Spokes (16)**—None broken or bent. Tightened to a uniform tension.
- Tires**—Good tread (17). Valves (18) completely airtight. Properly inflated to recommended pressure.
- Rims (19)**—Clean of all oil and grime. Free of dents or kinks.
- Chain (20)**—Proper tension, allowing $\frac{1}{2}$ inch of play. No stiff links. Clean, lubricated, and wiped of excess lubrication.
- Gearing (21)**—Clean and oiled. Three-speed gears adjusted to eliminate all slipping. Front (22a) and rear (22b) derailleurs adjusted for proper shifting with shifters (22c).

- Brakes (23)**
 - **Coaster:** even braking. Operate within a 20-degree back-pedaling motion.
 - **Hand:** even braking. All nuts tight. Front and rear brakes work without binding. Minimum of $\frac{3}{16}$ inch of rubber on brake pads (24). Brake pads aligned with rims and contact rims with a minimum movement of hand controls (25). No squeal when brakes are used.
- Cables (26)**—No frayed ends. No broken strands. All taut.
- Handlebars (27)**—Tightened securely. Grips (28) not worn; fit snugly. Adjusted to comfort of rider. Ends (29) plugged. In line with wheel.
- Saddle (30)**—Height, tilt, and fore/aft position adjusted to rider. All adjustments securely tightened. Seatpost (31) not extended beyond maximum mark on post.
- Rear red reflectors/lights (32)**—Visible for 300 feet. Lights/blinders functional with generator or batteries.
- Bike registration**—If required by local law, must be displayed on frame.
- Lights (optional)**—Front light visible for 500 feet. Generator or battery in good operating condition.
- Bell or horn (optional)**—In good operating condition. All accessories well-tightened and securely fastened. No broken frames or fasteners.



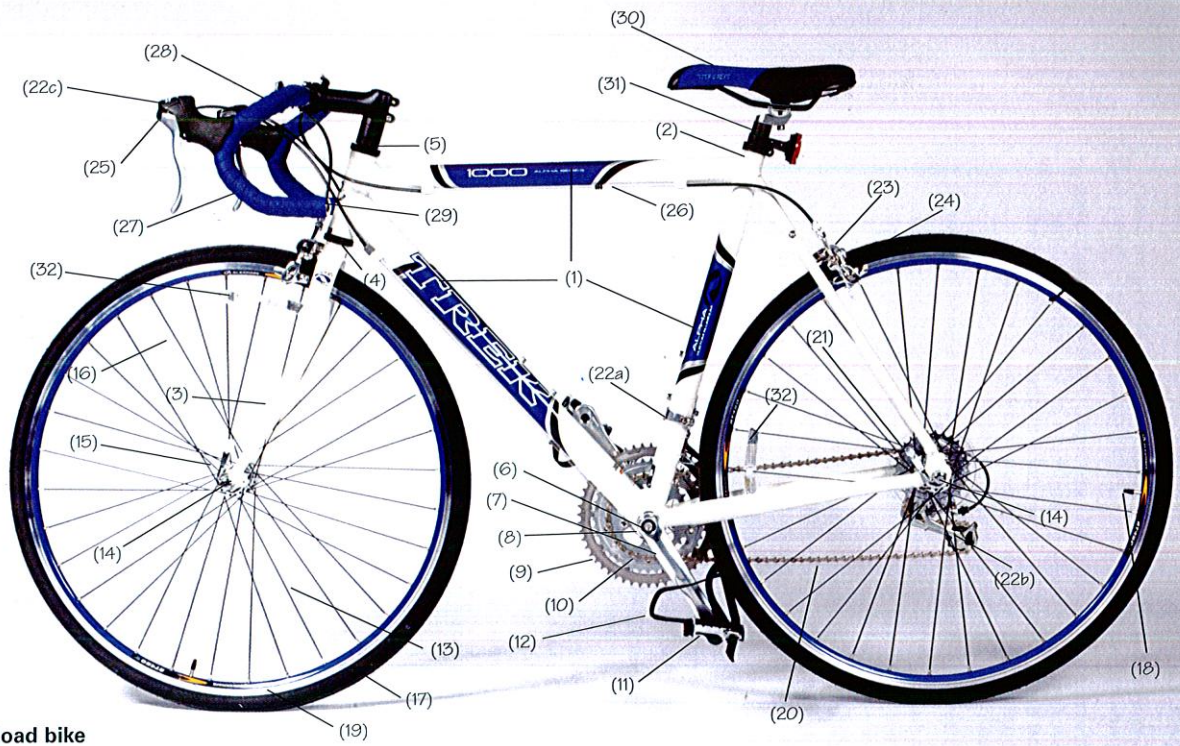

Road bike

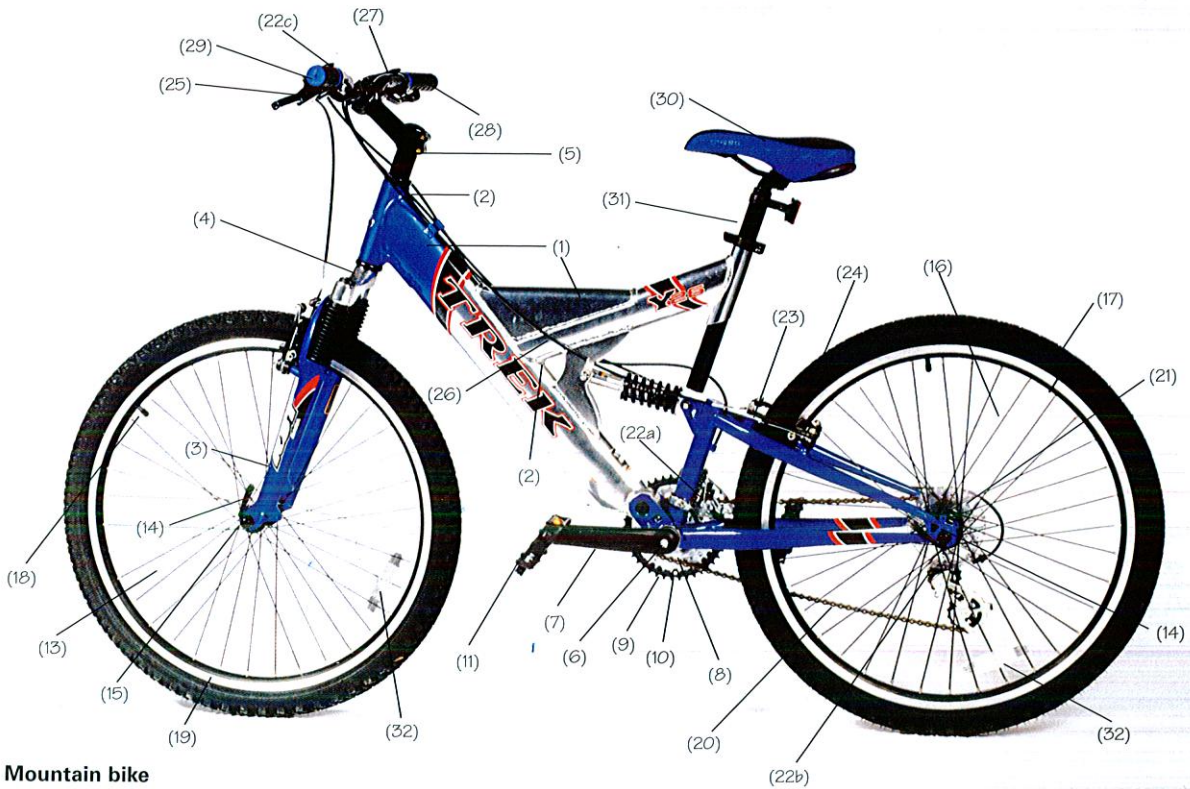

Mountain bike

Boy Scouts of America Bike Safety Guidelines

The Boy Scouts of America Bike Safety Guidelines are designed to make bicycle riding safer and more enjoyable for you and others. Review the guidelines with your merit badge counselor.

Physical Fitness. Biking is strenuous. Long treks and hill climbing should not be attempted without training and preparation. For Scout activity, all participants must present evidence of fitness assured by a complete health history from physician, parent, or legal guardian. The adult supervisor should adjust all supervision, discipline, and protection to anticipate any potential risks associated with individuals' health conditions. Should any participant have a significant health problem, the adult leader should require proof that the participant has been examined by a physician.

Helmets and Clothing. All cyclists must wear a properly sized and fitted helmet approved and stickered by either the Snell Memorial Foundation or the American National Standards Institute. On cool days, cyclists should dress in layers so they can adjust clothing to avoid chilling or overheating. When skies are clear, cyclists should cover up for protection from the sun.

Buddying Up. When the program activity is a bicycle expedition or trek, the buddy system must be used. When there is program activity emphasizing individual performance skills, one buddy observes while the other takes a turn. In competitive activity where the buddy system cannot be applied practically, all activity must be directly observed by the adult supervisor. (Scouts should be taught that biking with a buddy is best. When biking alone, apart from Scout activities, Scouts should be encouraged to tell someone their route, schedule, and destination before departing.)

Keeping Right. Cyclists should ride with the flow of traffic, as far to the right as possible. They should avoid curbs, storm drains, soft or loose gravel on shoulders, and other hazards.

Being Smart. Cyclists should obey all traffic laws, signs, signals, and street markings and should watch for changes in road conditions. They should ride only one to a bike, and should not ride after dark. They should not attempt stunts—trick riding

is only for professionals using special equipment. Even when cyclists think they have the right-of-way, they should yield to motor vehicles. No cyclist should ever hitch a ride on another vehicle. Do not wear headphones while riding.

Turns and Intersections. Before turning, cyclists should look left, right, back, and ahead. They should stop and look in all directions when entering a street from a driveway, parking area, sidewalk, or alley. All turns must be signaled using universal hand signs. Cyclists should walk their bikes through or across busy intersections.

Riding the Right Bike. Cyclists should ride only bikes that fit their size. The bike should allow for keeping feet flat on the ground while the cyclist is on the seat. The handgrips should be no higher than the shoulders or lower than the seat.

Accessories. Every bike needs a horn or bell and reflectors (front, back, and sides). Items should be carried only in baskets, or saddlebags, or on a rear carrier rack. A bike- or helmet-mounted mirror is recommended for those who must ride in traffic. For long trips, a bike-mounted container for drinking water is recommended.

Maintenance. Bikes must be kept clean and maintained—especially the brakes and drive chain.

Racing Right. Street racing is dangerous. Racing should take place only with supervision and on marked courses that have been set up to exclude other vehicle or pedestrian traffic, to eliminate fall hazards and minimize collision risks, and to define clearly the starting and finishing points.

Planning. Both the route and timing of bike trips should be planned to avoid heavy traffic and hazardous conditions. Biking is unsafe on wet pavement and on windy days. Plans should include hourly (at least) rest stops and a maximum of approximately six hours of time on the bike per day.

Discipline. All participants should know, understand, and follow the rules and procedures for safe biking, and all participants should conscientiously and carefully follow all directions from the adult supervisor.

Cycling Resources

Scouting Literature

Fieldbook; Deck of First Aid; Emergency First Aid pocket guide; *First Aid* merit badge pamphlet

Visit the Boy Scouts of America's official retail Web site (with your parent's permission) at <http://www.scoutstuff.org> for a complete listing of all merit badge pamphlets and other helpful Scouting materials and supplies.

Books

Armstrong, Lance, with Sally Jenkins. *It's Not About the Bike: My Journey Back to Life*. Berkley Publishing Group, 2001.

Baker, Arnie. *Smart Cycling: Successful Training and Racing for Riders of All Levels*. Simon & Schuster Trade Paperbacks, 1997.

Ballantine, Richard. *Richard's 21st Century Bicycle Book*. Overlook Press, 2001.

Mountain Bike Magazine editors. *Mountain Bike Magazine's Complete Guide to Mountain Biking Skills: Expert Tips on Conquering Curves, Corners, Dips, Descents, Hills, Water Hazards*. Rodale Press, 1996.

Burke, Edmund R. *The Complete Book of Long-Distance Cycling*. Rodale Press, 2000.

Forester, John. *Effective Cycling*. 6th ed. MIT Press, 1992.

Glowacz, Dave. *Urban Bikers' Tricks and Tips*. Wordspace Press, 1997.

King, Dave, with Michael Kaminer. *The Mountain Bike Experience*. Henry Holt & Company, 1996

Langley, Jim. *Bicycling Magazine's Complete Guide to Bicycle Maintenance and Repair*. Rodale Press, 1999.

Oliver, Peter N. *Bicycling: Touring and Mountain Bike Basics*. W. W. Norton & Company, 1995.

Pavelka, Ed. *Bicycling Magazine's Complete Book of Road Cycling Skills: Your Guide to Riding Faster, Stronger, Longer, and Safer*. Rodale Press, 1998.

———. *Bicycling Magazine's New Cyclist Handbook*. Rodale Press, 2000.

Rafoth, Richard. *Bicycling Fuel: Nutrition for Bicycle Riders*. 3rd ed. Bicycle Books Inc., 1993.

Reeser, John, ed. *Bicycling Magazine's Ultimate Ride Guide for Road and Mountain Biking*. Rodale Press, 1999.

Zinn, Lennard. *Zinn and the Art of Mountain Bike Maintenance*. Velo Press, 1998.

———. *Zinn and the Art of Road Bike Maintenance*. Velo Press, 2000.

Magazines

Bicycling
135 N. Sixth St.
Emmaus, PA 18098-0099
Web site: <http://www.bicycling.com>

BMX Plus!
Web site: <http://www.bmxplusmag.com>

Mountain Bike
135 N. Sixth St.
Emmaus, PA 18098-0099
Web site: <http://www.mountainbike.com>

Organizations

Adventure Cycling Association
P.O. Box 8308
Missoula, MT 59802
Telephone: 800-755-2453
Web site: <http://www.adv-cycling.org>

American Bicycle Association
P.O. Box 718
Chandler, AZ 85244
Telephone: 480-961-1903
Web site: <http://www.ababmx.com>

International Mountain Bicycling Association
P.O. Box 7578
Boulder, CO 80306
Telephone: 303-545-9011
Web site: <http://www.imba.com>

League of American Bicyclists

1612 K St., NW, Suite 800
Washington, DC 20006
Telephone: 202-822-1333
Web site: <http://www.bikeleague.org>

National Off-Road Bicycle Association (NORBA)

1 Olympic Plaza
Colorado Springs, CO 80909
Telephone: 719-578-4581
Web site: <http://www.usacycling.org/mtb>

USA Cycling

1 Olympic Plaza
Colorado Springs, CO 80909
Telephone: 719-578-4581
Web site: <http://www.usacycling.org>

Acknowledgments

The Boy Scouts of America thanks TREK Bicycle Corporation for its support of this edition of the *Cycling* merit badge pamphlet. TREK provided the bicycles, helmets, and other equipment seen in many of the photos in this pamphlet. Special thanks to Tyler Klein, general manager of the TREK Bicycle Store in Madison, Wisconsin, for his technical expertise and support; to sales manager Michael Tschanz; and to the entire staff at the TREK Bicycle Store for their assistance with photography.

We appreciate the help of the BSA's Four Lakes Council, Madison, Wisconsin, for its help with photography arrangements. Thanks to Richardson Bike Mart and Jim Hoyt, Richardson, Texas, also for assistance with photography.

Thank you to the League of American Bicyclists for its editorial and technical assistance with updating the text in this pamphlet, in particular the new section on mountain biking.

The BSA is grateful to the American Library Association for its assistance with updating the resources section of this new edition. For many years, the ALA has had a special committee charged with assisting the merit badge pamphlet series in this capacity, and it does so very effectively.

Thanks to John Donoughe (Eagle Scout, member of the Order of the Arrow, Wood Badge staff member, and life member of the League of American Bicyclists) for writing the 1996 edition, much of which has been retained in this 2002 edition.

The Boy Scouts of America gratefully acknowledges the cooperation of Huffy Bicycles and Rodale Press in the preparation of the 1996 edition of the *Cycling* merit badge pamphlet.

Photo and Illustration Credits

Brand X Pictures, Bugs and Insects,
©2001, all rights reserved—page 83

Comstock Inc., ©2001—page 84

HAAP Media Ltd., courtesy—cover
(*water bottles, tire pump,
bike route sign*)

©Jupiterimages.com—cover (*bike at top
left*) and page 58

U.S. Fish and Wildlife Service/Luther
C. Goldman, courtesy—page
85 (*top*)

Wikipedia.org, courtesy—
page 38 (*combination lock*)

Wikipedia.org/Ralf Roletschek,
courtesy—page 38 (*U-lock*)

Wikipedia.org/John Wilson, Savannah
River Ecology Laboratory (SREL),
courtesy—page 85 (*center*)

Wikipedia.org/Edward J.
Wozniak, DVM, Ph.D., courtesy—
page 85 (*bottom*)

All other photos and illustrations
not mentioned above are the property
of or are protected by the Boy Scouts
of America.

Darrell Byers—page 4

Roy Jansen—page 84

John McDearmon—all illustrations on
pages 10-15, 19, 25-26, 29-30, 43,
50-51, 53-57, and 61-63

Brian Payne—pages 3, 6, 38 (*top*), 42,
64, 80, and 89